



Use and maintenance manual
MAN.241 Rev.3



ORIGINAL

CMC XS23

Mobile elevating work platform

brand
model

C.M.C.
S23



0 ▶▶ Introduction ◀◀

Thank you for the trust you have showed us buying a CMC mobile elevating work platform (MEWP). We are sure you will be pleased with your choice.

0.1 ▶ Content of the manual ◀







This manual contains the technical specifications and instructions for transfer, use and maintenance of the MEWP. While drawing up this manual, we took into consideration all the operations that are part of a normal use and regular maintenance of the machine. So, for a correct and optimum use, you have to follow the described instructions carefully.

This manual has been drawn up in order to:

- ❑ Show the technical features of the machine;
- ❑ Describe the control stations and their commands;
- ❑ Provide with the instructions for the transport, placement and use of the machine;
- ❑ Describe the safety devices;
- ❑ Point out the potential risks and/or possible dangerous situations;
- ❑ Provide with the necessary instructions for the ordinary maintenance operations;
- ❑ Provide with the instructions for the filling of the check register.

 **THE USE AND MAINTENANCE MANUAL IS CONSIDERABLE AS A PART OF THE MACHINE.** In case of the MEWP sale, please send this manual to the new owner.

LEGEND OF SYMBOLS USED IN THIS MANUAL:

 (CAUTION)	= it warns the user about the risk of serious damages to people or to part of the equipment or the machine, if you do not obey the safety regulations.
 (WARNING)	= it notifies the possibility of minor injuries to people or little damages to the platform or machine parts.
 (FORBIDDEN)	= prohibition signal.
 (OBLIGATION)	= obligation signal.
 (CAUTION)	= it warns the user about the risk of environmental pollution.
* (OPTIONAL)	= it indicates an optional outfit.
 (IMPORTANT NOTE)	= indicates information and suggestions useful to work with the MEWP.

-  This manual is addressed to:
- **users:** operators, ground assistants, guard staff, safety manager, service manager;
 - **manufacturers, dealers, owners, lessors or lessee, brokers.**



0.2 ▶ Disclaimer ◀

C.M.C. declines all responsibility in case of partial or total non-observance of the following instructions

- ➔ Before any operation of use of the machine, the user is obliged to carefully read the text of this manual, with reference to sections relative to specific work activity to perform.
- ➔ The use of the machine must be entrusted only to trained and authorized staff. This manual cannot replace in any way a suitable experience that the staff in charge must have gained previously on similar machines or that they will be able to get on this machine, under the guidance of an already trained staff.
- ➔ The user must work within the functional limits of the machine and perform a constant and diligent maintenance, using only original spare parts indicated by C.M.C.
- ➔ The operator shall carefully know the safety standards foreseen by national and international legislations and apply them during all operations with the MEWP.

☞ **The guarantee of proper functioning and full compliance of the machine with the intended service is strictly dependent on the correct application of all the instructions contained in this manual.**

☞ **The non-compliance with the previous items automatically invalidates the warranty.**

0.3 ▶ Where and how to store the manual ◀

- ➔ **The manual must be stored and kept in the best possible condition (away from sunlight), in a suitable place, for the purpose of always being available for consultation.**
- ➔ **This manual (or its copy) must always be on the machine** (in a case near the turret) for an immediate consultation by the operator during working operations.

- ➔ **Another copy shall be held by the basket operator during the working period inside the internal documents case.**
- ➔ **In case of loss or deterioration, the replacement documentation must be requested to C.M.C. s.r.l, citing the code of this manual.**

0.4 ▶ Legislative references ◀



This manual has been drawn up according to the following national and international laws and directives:

Directive 2006/42/CE	EN 280:2015	EN 13001-3-1
Directive 2014/35/UE	Directive 2000/14/CE	EN ISO 12100
ISO 13849-1-2	ISO 3864	EN 60068-2-64
ISO 13850	ISO 4302	EN 60204-1
ISO 13854	ISO 4305	EN 60204-32
ANSI/SAIA A92.20-2020	ANSI/SAIA A92.24-2018	IEC 60529
ANSI/SAIA A92.22-2020	ANSI Z359.1	EN 62061
CAN/CSA B354.6 (2017)	CAN/CSA B354.7 (2017)	ISO 13857
AS/NZS 1418.10-2011	AS NZS 1418.10-2011_A1-2017	ISO 20381



0.5 ▶ Changes and integrations ◀

The information and legislative references present in this manual are those in force when the machine has been placed on the market.

Due to the constant and continuous improvement of their product by the manufacturers, the supplied machine could present some technical specifications different from those described on this manual. Any change will be however accompanied with specific documents attached explaining functional characteristics. In case of differences in comparison with the basic contents of this manual, the user is kindly asked to contact C.M.C. to receive supplementary technical specifications.

As this manual includes both current and optional components, you could find information not applicable to your machine.

C.M.C. reserves the right to update its production and its instruction manuals (without prior notice) according to the development of the technique, to the acquisition of new experiences and/or the change of law provisions, without being anyway obliged to intervene on the previously sold machines and on their manuals.

No part of this publication can be translated, modified or reproduced (even partially) without the expressed authorization of C.M.C. s.r.l.

C.M.C. reserves the right to modify - totally or partially - any data or specification of this publication (without prior notice).

Data and references indicated in this manual are those in force at the time of printing.

Year 2020
C.M.C. s.r.l.



1 ►► Specifications ◀◀

1.1 ► Technical data ◀

PERFORMANCE		
Max. working height	23,00 m	75.46 ft
Max. work outreach (long area with 200 kg)	12,40 m	40.68 ft
Max. load on the basket	200 kg	441 lb
Turret rotation	+/-355° (tot. 710°)	
Basket rotation (*optional)	+/-90°	
Work angle of Jib	90°	
Max. slope to stabilize	13° / 23%	
Max. ramp attack slope (front/without jib)	14°-15° / 25-27%	
Max. slope to travel (longitudinally/transversally)	17°-10° / 31%-18%	
Travel speed	0,60-1,40 km/h	0.37-0.88 mph

DIMENSIONS		
Basket height	1,10 m	3.61 ft
Basket width	0,60/0,70 m	1.97/2.30 ft
Basket length	0,80/1,40 m	2.62/4.59 ft
Total length (with two-men basket rotated)	5,50 m	18.04 ft
Total length with basket support rotated	5,07 m	16.63 ft
Height in transport position	1,98 m	6.50 ft
Total width (without basket)	0,88 m	2.89 ft
Clearance from the ground in transport position	0,20 m	0.66 ft
Max. height that can be climbed over	0,75 m	2.46 ft
Tracks (L x w)	1,75 x 0,25 m	5.74 x 0.82 ft
Tracks enlargement (*optional)	0,85/1,25 m	2.79/4.10 ft

Max. longitudinal stabilization	5,20 m	17.06 ft
Max. cross stabilization	3,84 m	12.60 ft
Min. longitudinal stabilization	3,81 m	12.50 ft
Min. cross stabilization	2,46 m	8.07 ft
Intermediate cross stabilization	3,15 m	10.33 ft
Outriggers plate \emptyset	0,18 m	0.59 ft

WEIGHT AND PRESSURES		
Total weight (standard)	2865 kg	6317 lb
(R) Max. pressure on the foot	8,4 kg/cm ² (82,38 N/cm ²)	119.48 lb/in ²
(S) Max. pressure on the track	0,2 kg/cm ² (2,03 N/cm ²)	2.84 lb/in ²
(T) Max. pressure in travel	651 kg/m ² (6,38 KN/m ²)	133.34 lb/ft ²
(U) Max. pressure in work (4 feet opened)	225 kg/m ² (2,21 KN/m ²)	46.08 lb/ft ²
(V) Max. pressure in work (4 feet closed)	224 kg/m ² (2,20 KN/m ²)	45.88 lb/ft ²
(Y) Max. pressure in work (2 feet closed + 2 feet opened)	258 kg/m ² (2,53 KN/m ²)	52.84 lb/ft ²

POWERS	
Standard hydraulic feed	1) Honda iGX390 petrol, 8.7 kW (11.7 HP), 3600 rpm
*Optional feeds	2) Yanmar L100 diesel, 6.8 kW (9.3 HP), 3600 rpm 3) Kubota Z602-E4B diesel, 10.8 kW (14.5 HP), 3200 rpm 4) Electric motor: 230/120/110 V 5) Motor G0901306, 9 kW, 48 V, with lith- ium batteries 160 Ah
Fuel tank capacity	6,1/15 l



Max values (speed/force) allowed according to USA/EU standards	
Max allowed lifting and descending speed of the MEWP	0,4 m/s (1.31 ft/s)
Max allowed boom extension and withdrawal speed	0,4 m/s (1.31 ft/s)
Max allowed rotation speed	0,7 m/s (2.3 ft/s)
Max allowed manual force in the basket with 1 operator	400 N

		Tightening torque
Slewing ring bolts	M16 cl 10.9	28 daNm

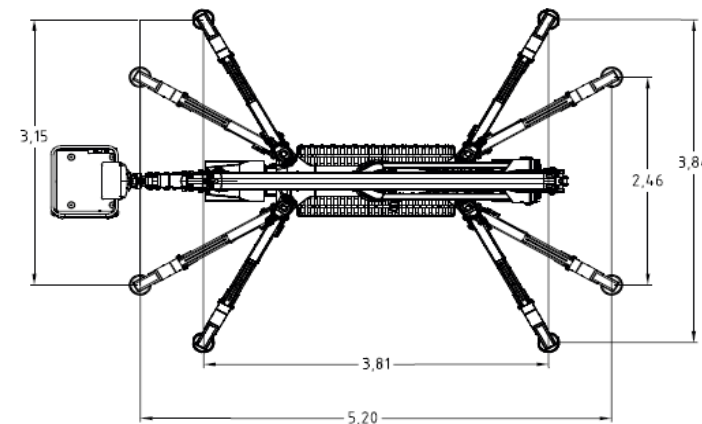
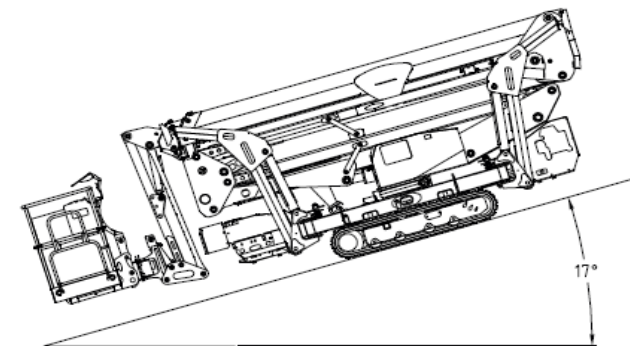
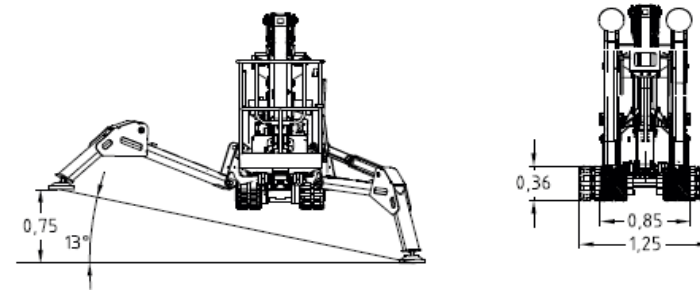
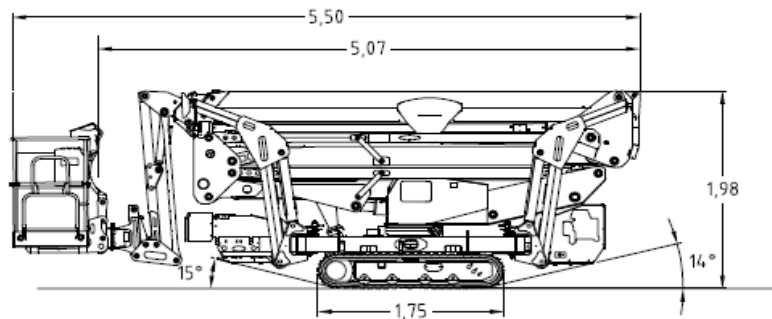



(S)



(T)

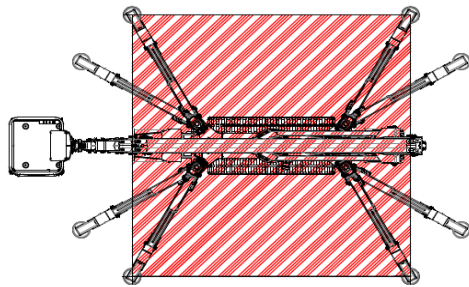

(U)

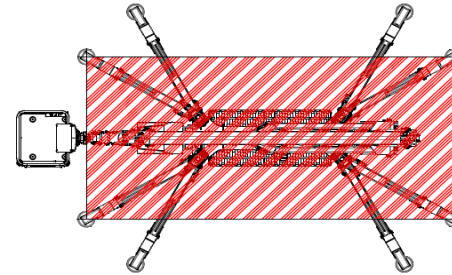

(V)

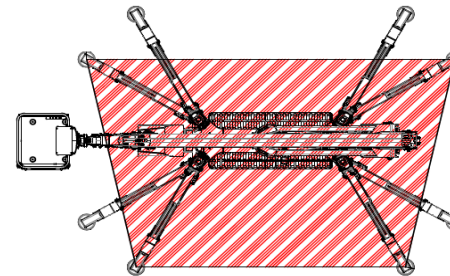

(Y)



1.2 ▶ Identification plate ◀

On the turret there is a tag where all identification data of the machine are engraved:

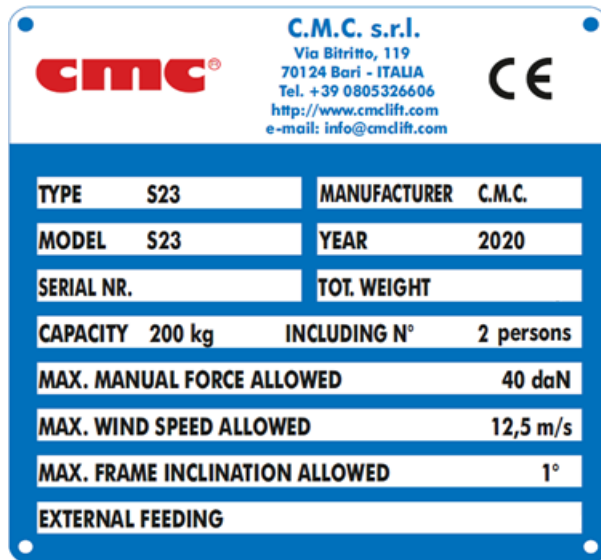

Picture 1: identification plate.

1.3 ▶ CE certification ◀

C.M.C. s.r.l. states under its own responsibility that **S23** was designed and produced in compliance with national and European standards, and that the machine is identical to the model submitted to control and test for the “CE certification” by the Notified Institute **nr. 1878 - VERICERT s.r.l. - via L. Masotti, 5 - 48124 Fornace Zarattini (RA) - Italy.**

A copy of the CE Certificate is attached to the manual.

1.4 ▶ TÜV certification ◀

C.M.C. s.r.l. states under its own responsibility that **S23** was designed and produced in compliance with US standards ANSI/SAIA A92.20:2018 and that the machine is identical to the model submitted to control and test for the “TÜV certification” by **TÜV SÜD America Inc.**

TÜV SUD America Inc. is an OSHA recognized NRTL and a Standards Council of Canada accredited certification body.

1.5 ▶ Classification ◀

The mobile elevating work platform (MEWP) **S23** belongs to **group B**: the vertical projection of the center of the area of the MEWP in different platform configurations specified by the manufacturer can be outside the tipping lines (EN 280 par. 1.4 - ANSI/SAIA A92.20 par. 3).

As for the displacement, it belongs to **type 1**: travelling is only allowed with the MEWP in its transport configuration or in the stowed position (EN 280 par. 1.4 - ANSI/SAIA A92.20 par. 3).



1.6 ▶ Loading cycles ◀

The machine is expected to live for 40.000 loading cycles¹ (i.e. 10 years, for 40 weeks per year, for 20 hours per week, for 5 loading cycles per hour). **Within this term of time, the machine must undergo at least 2 (two) deep checks** (structural, mechanical, electric, elements, etc.), **in case of particularly heavy uses** (frequent use at the performance limit, particularly unfavorable environmental conditions such as steel plants, paper mills and so on) **it is better to increase checks**. Anyway, **it is a good rule to have the state of the machine checked by the manufacturer factory or by an authorized workshop, at least every 1500 - 2000 hours of work or once per year.**

1.7 ▶ Working diagram ◀

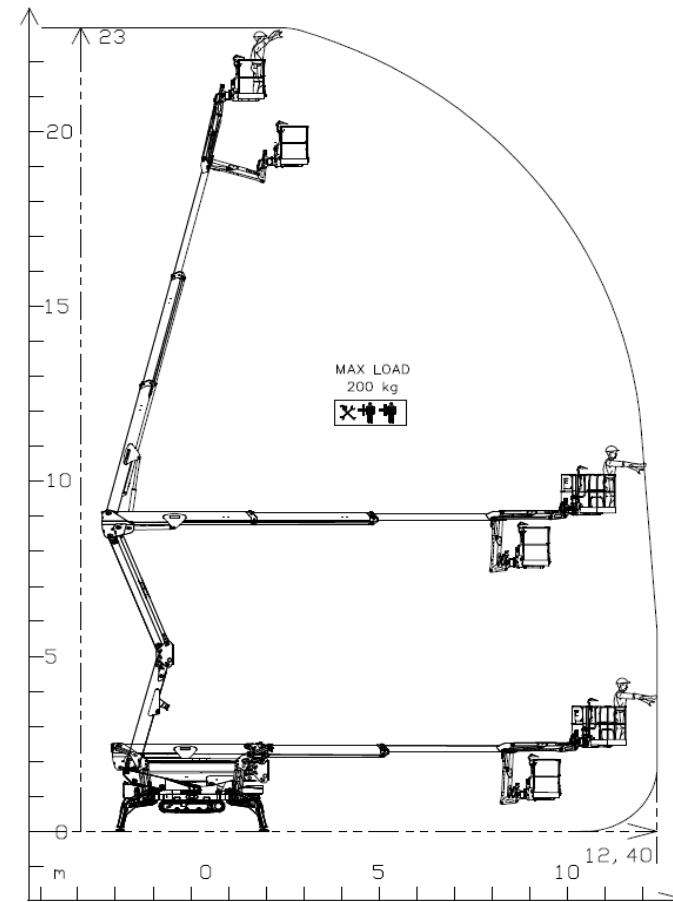

Picture 2a: working diagram.

¹Loading cycle: a cycle starts from the access position, continues performing the work and finishes returning to the access position.

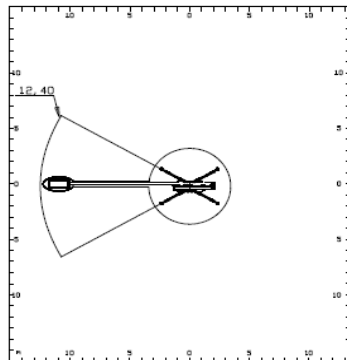
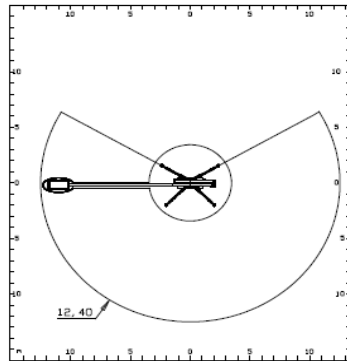
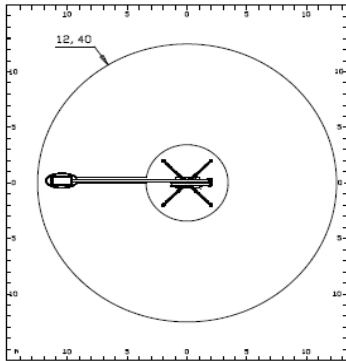

Picture 2b: working areas.



2 ▶▶ Description and scope ◀◀

2.1 ▶ Machine definition ◀

The machine is called S23 and it is a mobile elevating work platform (MEWP):

- machine/device intended for moving persons, tools and material to working positions, consisting of at least a work platform with controls, an extending structure and a chassis (ANSI/SAIA 92.20 par. 3);
- mobile machine intended to move persons to working positions, where they are carrying out work from the work platform, with the intention that persons are getting on and off the MEWP only at access positions at ground level or on the chassis and which consists as a minimum of a work platform with controls, an extending structure and a chassis (EN 280 par. 3.1).



It is forbidden to use the MEWP with methods and/or conditions other than those specified and approved by the manufacturer.

2.2 ▶ Machine purpose ◀

The MEWP **S23** is a machine which enables the operators to reach the working place when this is high-positioned.

The machine has been designed for an essentially vertical use. It must be transported only when it is totally folded in the transport position.

- ➔ **The use of the machine is allowed only to professional staff, properly trained and specialized.**

2.3 ▶ Description of the main components ◀

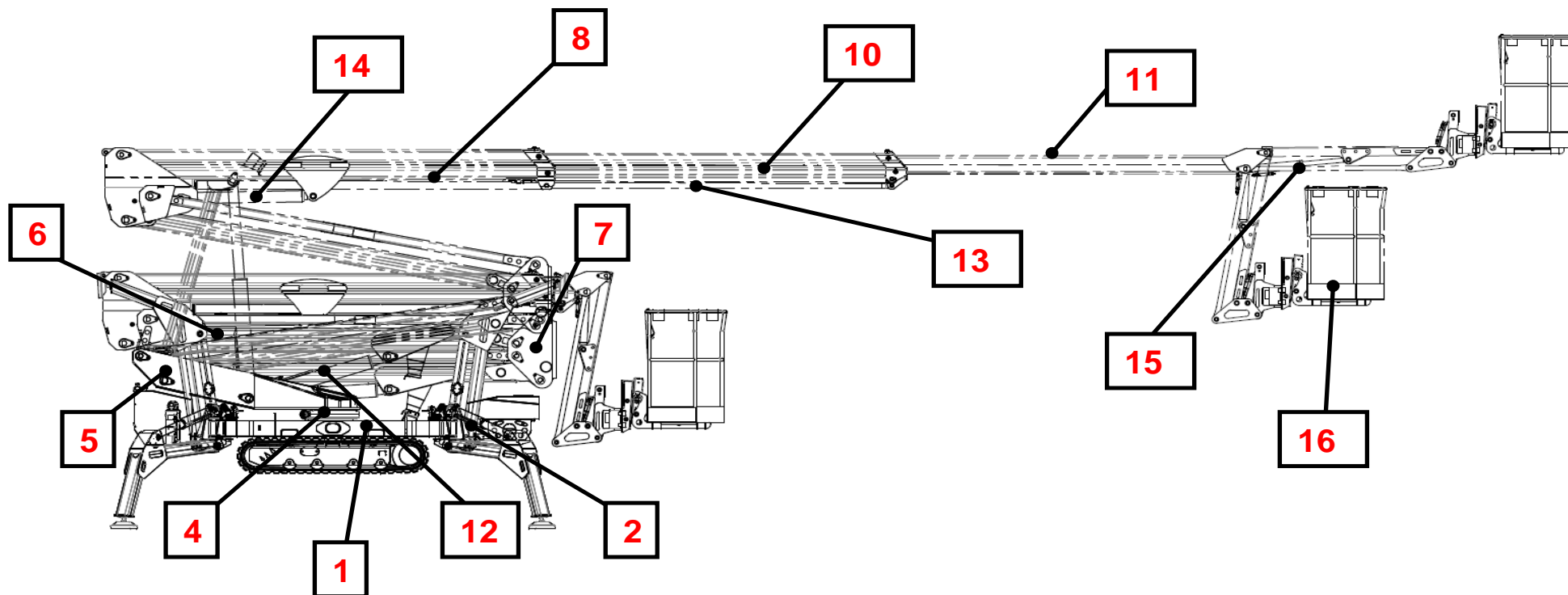

Picture 3: main components of the MEWP.



2.3.1 ▶ Frame

The frame **1** (Picture 3) is a steel structure having a quality appropriate in order to distribute the weight of the equipment when the MEWP is in driving position. The frame features 4 hydraulic jacks for stabilization. The base for the support slewing ring is on the frame and through the rotation unit allows the tilting of the equipment.

2.3.2 ▶ Turret

The turret **5** (Picture 3), made of quality steel, is fixed to the bearing (slewing ring). The rotation of the superstructure is allowed by a hydraulic power with brake normally closed, constrained to the turret.

2.3.3 ▶ Pantograph

The pantograph **6** (Picture 3) consists of two pairs of parallel booms (pantograph upper crank and pantograph lower crank) and of the pantograph connecting rod **7** (Picture 3). The booms (tubular with rectangular section, bended and electro-welded) and the connecting rod are made with high quality steel sheets. The movement of the pantograph (lifting and lowering the pantograph) is obtained thanks to the hydraulic cylinder for lifting the pantograph **12** (Picture 3). This cylinder is fastened to the turret (barrel side) and to the upper pantograph crank (rod side) and is equipped with double-acting balancing valve.

The double pantograph has an operating field from 0° to about +65° (with respect to the horizontal).

2.3.4 ▶ Telescopic boom

The telescopic boom **8** (Picture 3) is hinged to the turret. The telescopic boom is made up of three elements: a fixed boom hinged to the turret and two extensible booms **10** **11** (Picture 3).

The extraction movement (or return) of the telescopic boom is obtained by moving the "telescopic boom extraction cylinder" **13** (Picture 3).

The lifting (or lowering) movement of the telescopic boom is obtained by moving the "telescopic boom lifting cylinder" **14** (Picture 3).

2.3.5 ▶ Basket

The basket **16** (Picture 3) is connected to the second extensible boom through the jib **15** (Picture 3). It is made with tubular aluminium or steel, bent, welded and hot galvanised, covered in fibreglass* or made in a structure completely in fibreglass*; it is equipped with side or front opening for operator access. The opening is self-hinged and built to avoid accidental openings. The platform is provided with attachments for the safety belts, a guard-rail at a height of 1.1 m from the floor, an intermediate guard-rail and a foot guard band along all the sides of the platform. The floor is in anti-skid and self-draining aluminium.

3 ▶▶ Control stations ◀◀

3.1 ▶ Machine switching on/off station ◀

The machine switching on/off station is normally positioned on the right side of the frame (Picture 4).

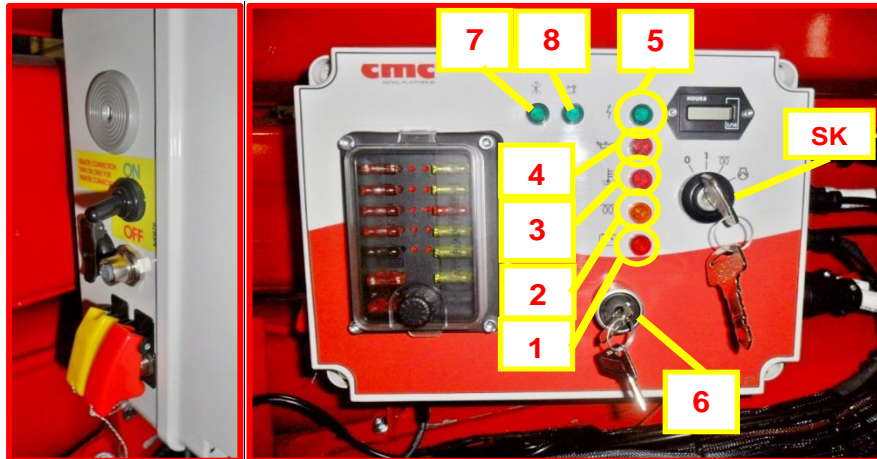

Picture 4: machine switching on/off station in case of diesel engine.

It consists of an electrical panel (Picture 4) in which there are:

- **the SK key:** through it, it is possible to turn on the electric system and start the endothermic engine;
- **the hour counter;**
- **the green light 5 indicating system power supply:** it is on when the SK key is in position 1;
- **the red light 4 which signals low pressure to the engine oil;**
- **the red light 3 which monitors coolant level;**
- **the orange light 2 indicating the spark plugs working;**
- **the red light 1 which signals an alternator failure;**

- **the control station selector (*optional) 6:** at left it enables the basket wired control station, at right the radio control on the ground.
- **the platform consent light 7:** if lighted on, it allows the maneuvers of the aerial part only with stabilization correctly performed.
- **the stabilization consent light 8:** if lighted on, it allows the movement of the outriggers only with the boom and the pantograph rested on their supports.
- **the fuse box.**

In addition, on the left side of this case (Picture 4), you can find:

- **the red sealed key to enable the emergency electropump (*optional);**
- **the yellow sealed key to bypass the emergency** in the basket only in case of danger;
- **the remote connection kit** (lever and connector) (*optional) to receive technical assistance from C.M.C. Service or authorized workshops;
- **the 12 V socket;**
- **the buzzer.**



Before performing any operation, it is necessary to place the ignition key in position 1.

If the machine supplied is equipped as full lithium version (*optional), the switching on/off station is the following one:



Picture 4b: machine switching on/off station in case of full lithium version.

- **the SK key:** through it, it is possible to turn on the electric system and start the electric engine;
- **the green light 5 indicating machine power supply:** it is on when the SK key is in position 1;
- **the platform consent light 7:** if lighted on, it allows the maneuvers of the aerial part only with stabilization correctly performed.
- **the stabilization consent light 8:** if lighted on, it allows the movement of the outriggers only with the boom and the pantograph rested on their supports.
- **the fuse box;**
- **the battery charge indicator 10;**
- **the hour counter.**

3.1.1 ▶ Ignition of the endothermic engine

In order to start the endothermic engine, turn the SK key all the way to the right up to the symbol .

Before starting the engine, especially if the MEWP is used in workplaces with low atmospheric temperatures, it is advisable to heat the spark plugs of

the machine engine while keeping the key on the symbol  for a few seconds: this will cause the corresponding orange light 2 (Picture 4) to turn on.

The ignition of the endothermic engine can also be carried out with the radio/wired control. Using it on the ground or in the basket:

- turn the SK key to position 1;
- move the lever in the Picture 5 upwards, present on the left bottom side of the radio/wired control (Picture 8);
- in this case, the green light 5 (Picture 4) will light up on the switching on/off station to signal the correct power supply of the machine.



Picture 5: power on/off lever on the radio/wired control.

To switch off the endothermic engine, you can alternatively:

- turn the SK key all the way to the left on position 0;
- lift the lever in Picture 5, on the radio/wired control;
- press, in emergency situations, one of the emergency buttons on the machine (par. 4.5.1).

3.1.2 ▶ Ignition of the electric engine (*optional)

If you choose to use the auxiliary electric engine (*optional):

- connect the 110/120/230 V socket to the nearest electrical source (Picture 6);

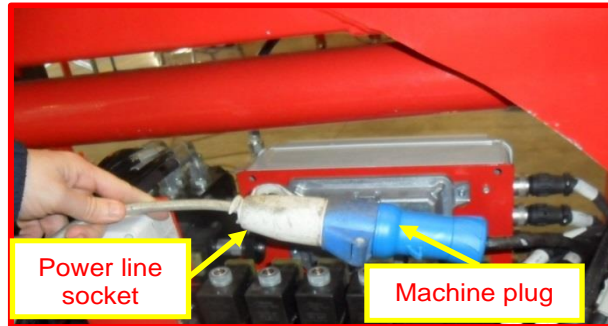

Picture 6: power line socket.

- from the radio/wired control, start the engine by pushing the lever in Picture 5 downwards;
- the power supply is signaled by the lighting up of the green led  (Picture 4) on the switching on/off station.

To switch off the electric engine*, it will be enough to alternatively:

- turn the SK key all the way to the left on position 0;
- lower the lever mentioned above on the radio/wired control;
- press, in emergency situations, one of the emergency buttons provided on the machine (par. 4.5.1).

3.1.3 ▶ Other power supplies (*optional)

The MEWP can also be equipped with an alternator (Picture 7a - *optional) capable of providing dual power supply at 110 V and 230 V. The desired one can be set thanks to a special electric selector (Picture 7a - *optional) fixed to the frame.



Picture 7a: alternator and selector (*optional).

This allows you to have electrical outlets of both voltages (Picture 7b): on the ground to power the electric motor and/or in the basket to power work tools.



Picture 7b: dual power sockets.



Moreover, the machine can be supplied on request with a 48 V electric engine powered by 160 Ah lithium batteries. The start and stop of the 48 V electric engine will be the same shown above for 110/120/230 V electric engine.



It is not possible to have the 48 V electric engine and the 110/120/230 V one activated on the machine at the same time.



It is not possible to turn on both the endothermic engine and the electric engine at the same time.

To recharge the lithium batteries pack:

1. couple the 110/120/230 V socket (power line) to the plug on the machine and lift the button provided on the machine's thermal magnetic panel;
2. from this moment the batteries will be charging and, if the electric system is ON, the progress of the charging process will be shown on the control station led panel (Picture 9).



When the state of batteries charge, during the use, reaches the lowest level (under 10%), all work maneuvers will be interrupted, and it will only be possible to close the machine again.



It is absolutely forbidden to direct high-pressure jets of water onto the support containing the battery pack. High water pressure could generate serious and irreversible problems in the operation of the machine.

3.2 ▶ Platform control stations ◀

There are two platform control stations:

1. the main one (operating) is the AUTECH control station (*optional) fixed and cabled in the basket (Picture 12);
2. the second one (emergency) is the AUTECH radio control station (Picture 8);
3. the third one (emergency) is totally hydraulic with electrovalves located on the frame (Picture 15).



It is not possible to use two different control station at the same time.

The system will select as actual control station the first one that will be used by the operator. Once the AUTECH remote control station is connected, it will become the actual control station, and in order to select a different control station you need to turn off and back on the system by the ignition key or any of the emergency buttons on the machine (except the one on AUTECH remote control).

3.2.1 ▶ Platform (emergency) control station

The platform (emergency) control station from the ground consists of the AUTECH radio control (Picture 8).

It can be activated only by carrying out the connection procedure described below (radio control activation directly excludes the basket control station).

☞ Radio control link procedure:

1. To connect the radio control, press the green Start/Link button **SL** (Picture 7) down on the left side.
2. the green led light "Power" on the upper right side of the electronic panel (Picture 9) of the radio control comes on.



Picture 8a: start/link button on radio control.

3. if the radio control is not correctly connected to the machine, the green led "Power" flashes intermittently and a buzzer on the electric box emits an intermittent acoustic signal. Press the start/link button again: when the connection is complete, the buzzer stops and the green led starts to light up at the rate of two flashes interspersed with a pause.

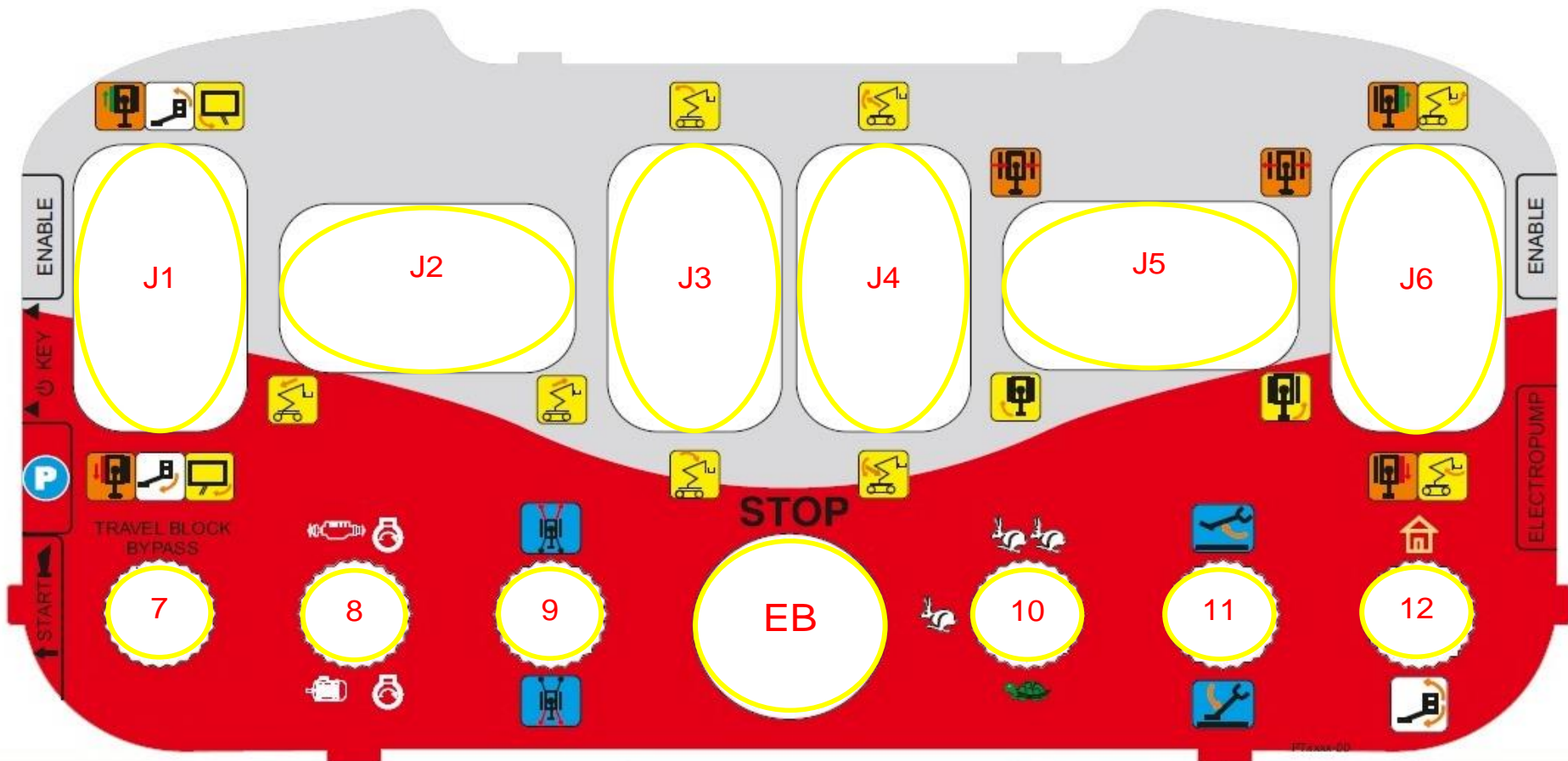

Picture 8b: radio control station.



The radio control has the following commands (Picture 8):

- on the left side:
 - **a green start/link key;**
 - **a blue coding key CK** (Picture 14), which puts the console in communication with the machine control unit. Be careful not to lose it!
 - **parking button P**: it has multiple functions; one of the most important is the automatic return of the booms in the rest position.
- on the central electronic panel:
 - **joystick J1 for travel of left track (orange) / basket levelling (white) / basket rotation (yellow);**
 - **joystick J2 for telescopic boom extraction/return (yellow);**
 - **joystick J3 for boom lifting/lowering (yellow);**
 - **joystick J4 for lifting/lowering and extraction/return of pantograph (yellow);**
 - **joystick J5 for narrowing/widening of tracks (orange) (*optional) / turret rotation (yellow);**
 - **joystick J6 for travel of right track (orange) / jib lifting/lowering;**
 - **emergency red mushroom-shaped button EB** that blocks the machine, removing the power supply to the control circuits. This button has priority over all other commands; thus, it allows only manual descent to the ground. The emergency button has a mechanical locking device; therefore, it must be unlocked by turning it clockwise to reactivate the normal machine working.

- **lever 7 for travel block bypass:** it allows to bypass the travel block in case of maximum slope reaching, keeping the lever upward;
- **lever 8 for endothermic or electric* engine power on/off;**
- **lever 9 for lowering front or rear stabilizers during loading/unloading operations;**
- **travel speed selector 10:** “turtle” mode = slow speed, “hare mode” = medium speed (*optional), “double hare” mode = high speed (*optional);
- **lever 11 for automatic stabilization/destabilization;**
- **lever 12 for “Home function” / basket levelling (dead man device).**



Carry out the basket levelling operation only when the aerial part of the MEWP is in transport configuration.



It is strictly forbidden to carry out the basket levelling operation when the machine is developed.

- on the right side:
 - **electropump activation button.**

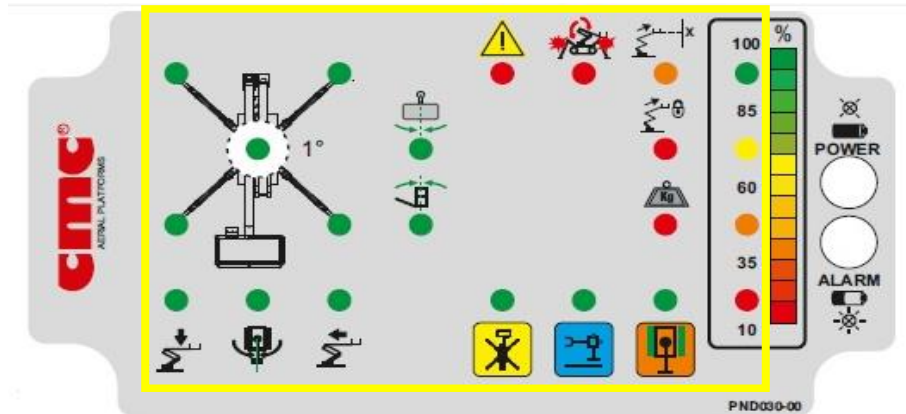

Picture 9: led panel with indicator lights.

1		3		5	6	7	8
	10		12			15	16
17		19	20			23	24
25	26	27		29	30	31	32

Table 1: assignment number for leds matrix.

1. LED – LEFT FRONT STABILIZER TO THE GROUND
- 2.
3. LED – RIGHT FRONT STABILIZER TO THE GROUND
- 4.
5. LED – DANGER/GENERIC FAULT
6. WARNING LIGHT – ANTI-CRASH SYSTEM
7. EARLY WARNING LIGHT - MOMENT LIMITER (*optional)
8. LED – 85-100% BATTERY CHARGE (*optional)
- 9.
10. LED – FRAME LEVELLED
- 11.
12. LED – BASKET CENTRED
- 13.
- 14.
15. WARNING LIGHT – MOMENT LIMITER BLOCK (*optional)
16. LED – 60-85% BATTERY CHARGE (*optional)
17. LEFT REAR STABILIZER TO THE GROUND

- 18.
19. RIGHT REAR STABILIZER TO THE GROUND
20. LED – BASKET LEVELLED
- 21.
- 22.
23. LED – BASKET OVERLOAD (*optional – only with load cell)
24. LED – 35-60% BATTERY CHARGE (*optional)
25. LED – BOOMS CLOSED
26. LED – TURRET CENTRED
27. LED – BOOMS WITHDRAWN
- 28.
29. LED – AERIAL PART USE CONSENT
30. LED – MACHINE STABILIZED
31. LED – MACHINE READY TO TRAVEL
32. LED – 10-35% BATTERY CHARGE (*optional).



If only the bottom led (10%) flashes, the battery pack (*optional) charge is too low (under minimum threshold) and the machine is near to go in block.

3.2.1.1 ▶ Recharge of radio control batteries

The remote control is equipped with two interchangeable batteries (one mounted and one spare).

It is advisable to always keep the unused battery charged and, in any case, to ensure that it is being charged during non-working hours.

To charge the battery, simply allocate it in the charging compartment of the remote control storage location (Picture 10).



Picture 10: charging compartment of the remote control battery.

If, during works, the battery of the AUTECH radio control is low, it could become a wired remote control by cabling its plug to the frame connector (Picture 11).



Picture 11: frame and basket connector for wired remote control.

3.2.2 ▶ Basket (operating) control station

The main control station is in the basket and consists of an AUTECH console, connected to the plug in the basket and fixed on a support. The basket control station can be a second AUTECH control station supplied as *optional to be fixed permanently in the basket or the radio control, supplied as ground command, fixable on basket when it is necessary.



The commands and the functions contained on the fixed basket control station (Picture 12) are about the same as those of the radio control station in Picture 8 and are indicated by the same symbols described above.

In the fixed basket (operating) control station, clearly, the parking button **P** and the lever **7** are missing.

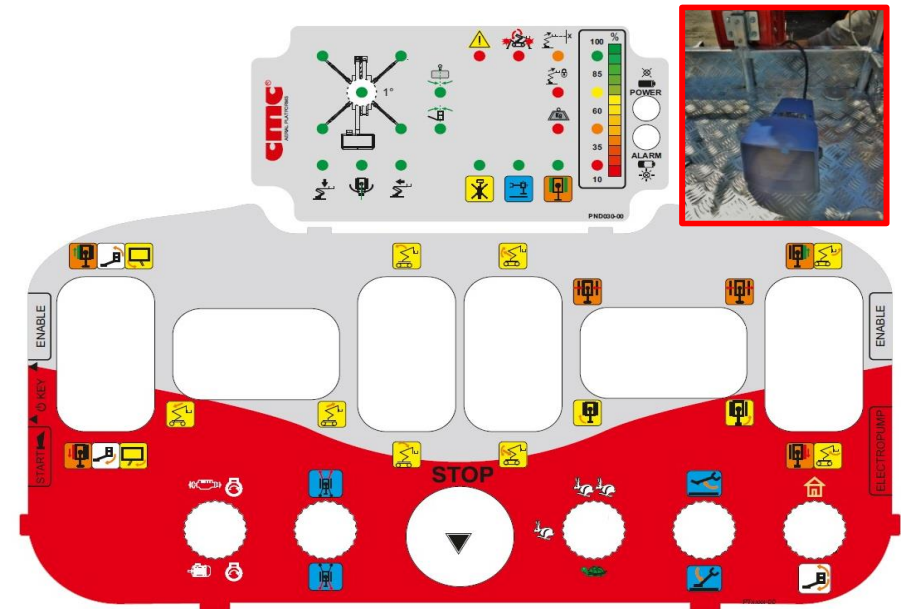

Picture 12: basket control station + “dead man” pedal.



The “dead man” pedal (Picture 12), if present (*optional), must be pressed simultaneously with joysticks for all manoeuvres by the basket control station.

On the right side of electronic box, below the basket control station, there can be also a 12 V socket* and a 200 bar air/water hose*.

3.3 ▶ Emergency control stations ◀

The emergency control station includes:

- outriggers control station;
- errors display;
- emergency workbench for aerial part recovery.

3.3.1 ▶ Outriggers control station

The "outriggers control station" is fixed on the machine chassis. The manual stabilization/destabilization manoeuvres are carried out by the operator on the ground through the **stabilizers control levers** (Picture 13):

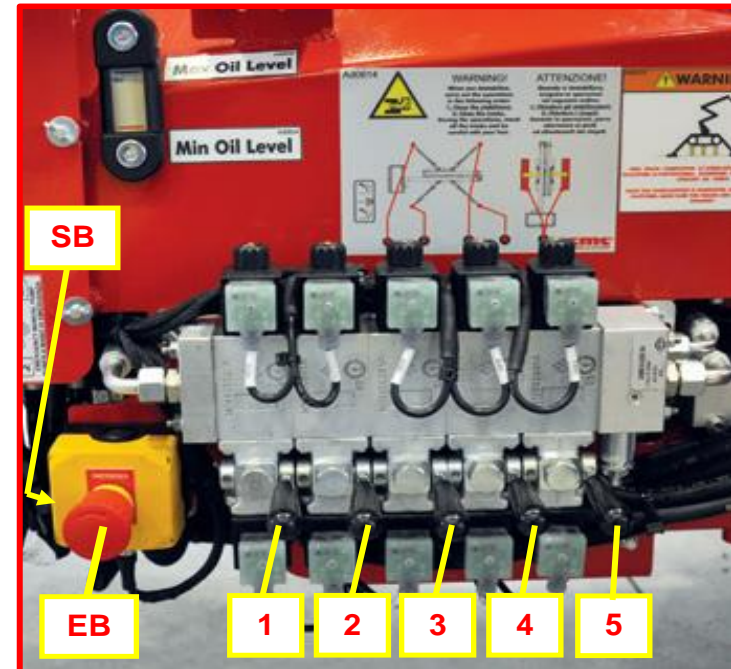

Picture 13: outriggers control station.

- lever **1** for left rear stabilizer;
- lever **2** for right rear stabilizer;
- lever **3** for left front stabilizer;
- lever **4** for right front stabilizer;
- lever **5** for tracks (*optional): it, upward, restricts the tracks and downward enlarge them.

Each lever, moved upward, runs the lifting of the stabilizer and if moved downward the lowering of it.

In addition, there is an **emergency red mushroom-shaped button EB** (Picture 13) that blocks the machine, removing the power supply to the control circuits. This button has priority over all other commands; thus, it allows



only manual descent to the ground. The emergency button has a mechanical locking device; therefore, it must be unlocked by turning it clockwise to reactivate the normal machine working.

On the left side of emergency button, there is a **“dead man” stabilizers button SB** (Picture 13): it must be held pressed together with other levers to stabilize or destabilize.

3.3.2 ▶ Display

The display (Picture 14), placed at the left side of the machine frame, shows the machine status or the error detection codes when there is any anomaly or system fault.



Picture 14: display.

☞ **Communicate the failure code shown on the display, when you require technical assistance to C.M.C. Service or authorized workshops.**

ELENCO DEGLI STATI MACCHINA/MACHINE STATUS LIST

N.	Display code	Descrizione	Description
20	Er	Programma macchina indefinito	Undefined machine program
21	P9	Stato macchina indefinito	Undefined machine status
22	C0	Macchina in traslazione	Machine in travel position
24	C2	Almeno uno stabilizzatore sul terreno	At least one outrigger on the ground
26	P0	Macchina stabilizzata inclinata	Machine stabilized and inclined
27	P1	Macchina stabilizzata	Machine stabilized
28	P2	Macchina stabilizzata sviluppata	Machine stabilized and developed
29	P3	Macchina inclinata sviluppata	Machine inclined and developed
30	P4	Macchina non stabilizzata sviluppata	Machine not stabilized and developed
31	P5	Macchina non stabilizzata inclinata e sviluppata	Machine not stabilized, inclined and developed

3.3.3 ▶ Emergency workbench

The emergency workbench (Picture 15) is placed on the left of the turret and it is useful in situations of emergency and machine block for the recovery of the MEWP aerial part by the operator on the ground.



Picture 15: emergency workbench with the main hydraulic distributor.

The functions of the different cursors will be described in the section about the recovery procedures of the aerial part (par. 4.5.5).



4 Use procedures

4.1 Environmental operational conditions

The equipment can work normally in the following environmental conditions (for uses in different conditions, a special equipment is required):

- **temperature from -25 °C (-13 °F) to +55 °C (131 °F)** (even +70 °C (158 °F) for short periods which do not exceed 24 h);
- humidity from 30% to 90% (at 20 °C);
- **max wind speed 12,5 m/s** (45 Km/h – 27.96 mph).

Do not cover the equipment with cloths in order to avoid condensation inside the electrical boards.
After storage in closed and very wet places for a long period, the machine could have some problems due to condensation in the electrical boards: in this case, please contact the Technical Assistance Service before use.



Do not operate in areas with dangerous environmental conditions: poor visibility, storms, lightning risk, etc.



Do not to operate inside refrigerating rooms.



Do not operate when the wind speed exceeds 12,5 m/s (45 km/h). We hereby enclose “Beaufort wind scale” (Table 2):

Wind strength		Wind speed		Effects on the mainland
Number Beaufort	description	m/s	Km/h	
0	Calm	0-0.2	1	Calm, smoke rises vertically
1	Light air	0.3-1.5	1-5	The wind direction is indicated by the smoke but not by the Windsock
2	Light breeze	1.6-3.3	6-11	Leaves rustling, Windsock moves
3	Gentle breeze	3.4-5.4	12-19	Leaves and small twigs move, flags raise
4	Moderate breeze	5.5-7.9	10-28	Dust and loose paper raised, small twigs and small branches move
5	Fresh breeze	8-10.7	29-38	Small trees begin to sway, small crests form on water
6	Strong Wind	10.8-13.8	39-49	Large branches in motion. Umbrella use becomes difficult
7	High wind	13.9-17.1	50-61	Whole trees in motion. Effort needed to walk against the wind
8	Fresh gale	17.2-20.2	62-74	Twigs broken from trees, difficult to move
9	Strong gale	20.3-24.4	75-88	Minor damages to buildings, tiles removed
10	Storm	24.5-28.4	>89	Trees uprooted, severe damages to buildings

Table 2: Beaufort scale.



We recommend the use of an anemometer, to determine direction and speed of wind.



Any addition that increases the wind load on the MEWP, such as warning signs, is prohibited.



4.2 ▶ Safety distances ◀

Below there are the safety distances to be kept by qualified staff (alternating current):

Voltage field of electric line	Minimum safety distance
Up to 300 V	Avoid contact
300 V < x > 750 V	1 ft. 0 in. (30,5 cm)
750 V < x > 2 kV	1 ft. 6 in. (46 cm)
2 kV, < x > 15 kV	2 ft. 0 in. (61 cm)
15 kV < x > 37 kV	3 ft. 0 in. (91 cm)
37 kV < x > 87.5 kV	3 ft. 6 in. (107 cm)
87.5 kV < x > 121 kV	4 ft. 0 in. (122 cm)
121 kV < x > 140 kV	4 ft. 6 in. (137 cm)



It is forbidden, in any case, to touch live electrical conductors.

4.3 ▶ Transport, storage and packaging ◀

In order to load/unload the platform, it is possible to use a travelling crane of adequate capacity, sling the MEWP by the connections on the frame (Picture 16).



Picture 16: hooks for sling and transport.

- ☞ Lifting operations must be carried out when the machine is closed.
- ☞ Be careful not to damage machine.
- ☞ Always use the personal protection equipment; do not handle ropes or chains without gloves.
- ☞ The presence of people in proximity of MEWP during the operations is forbidden.

Alternatively, the loading/unloading can be done through ramp, exploiting the motricity of the machine as well as its ability to overcome **slope attacks lower than 15° (27%)**. If you choose this option, please proceed with the following procedure, carefully reading the danger notes suggested.

- ☞ Comply with the rules in force about width, height, weight and transport speed allowed.
Check that the limit gauges are compatible with the features of the route to be made (i.e. galleries, bridges, electrical and phone lines, etc.).



WARNING! In both cases, it is advisable to remove the basket to favor the operations and reduce encumbrances.



Always use the radio control for loading/unloading operations.



4.3.1 ▶ Loading/unloading through ramp



Check that no one is in proximity and that the MEWP is in transport configuration.



In order to ensure a better stability during loading/uploading operations, it is possible to extract the tracks (*optional) widening the ground encumbrance, moving to the right the joystick **J5** on the radio control (Picture 8).



Place the couple of adequate ramps in correspondence of the machine tracks.



Check that the ramps slope does not exceed 17° (31%) and that those are perfectly clean from grease, mud, snow or ice.



WARNING! If you get the machine on a truck, use loading ramps with suitable dimensions and strength. Secure the machine to the truck plane by couplings on the chassis. Ensure that the machine is switched off during the transport.

1. Switch on the MEWP engine.
2. Connect and use the radio control.



Check that the slope of the ramps attack is not higher than 14° (25%) and that they are perfectly clean from grease, mud, snow or ice.

3. Control the travel maneuvers slowly and exclusively by radio control. Travel and climb with the MEWP set as shown below: the basket shall always be placed at the rear of the machine.

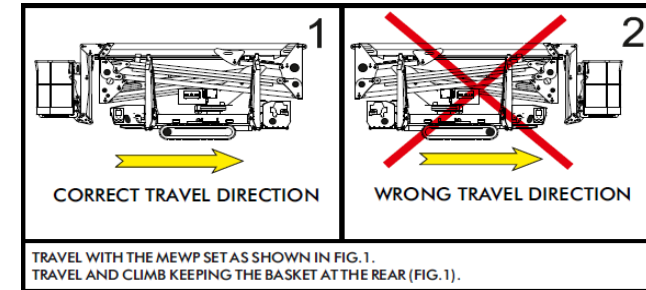

In order to favor machine loading/unloading through ramp, with the MEWP in transport position, even if it is not stabilized, you can press the parking button **P** (Picture 8) to:

- lift/lower the jib;
- rotate and level the basket;
- return the booms on their support.



In order to avoid the overturning of the MEWP, use the roll-over control lever **9** (Picture 8), present on radio control station: it moves front or rear outriggers closer to the ground.

4.3.2 ▶ Travel

The machine, thanks to a variable flow engine, has three levels of speed identified by three different symbols:

- "turtle": minimum speed;
- "hare": average speed (*optional);
- "double hare": maximum speed (*optional).



Check that no one is in proximity and that the MEWP is in transport configuration.



! In order to ensure a better stability during travel operations, it is possible to extract the tracks (*optional) widening the ground encumbrance.

! Check that the travel slope does not exceed the maximum longitudinal limit of 17° (31%) and the maximum transversal limit of 10° (18%). Check that the soil is clean from grease, mud, snow or ice.

! **WARNING!** The hydraulic system through which the maximum speed (“double hare”) is activated is a serial system (*optional). Therefore, it may be necessary to intervene with manual corrections during handling. Be very careful to travel with maximum speed!

Travel operations shall be made with the basket placed at the rear of the machine.

! During travel, if necessary, the parking button **P** on radio control allows to lift jib in order to avoid obstacles or its contact with the ground; moreover, it is possible lower two front stabilizers or two rear stabilizers until to brush up against the soil, using the lever **Q** (Picture 8) to balance the weight of machine.

! Always use the radio control from the ground for travel operations.

⊘ C.M.C. forbids you to travel from the basket, because it can entail risks for the safety of the operator on board.

! The travel slope limits are lower from the basket control station: 11° (pre-alarm at 8°) longitudinally and 5° (pre-alarm at 2°) transversally. If the basket operator decides to travel the MEWP from basket control station, he shall lower completely the jib.

4.3.2.1 ▶ Travel commands on radio control

In order to perform a travel, using the radio control (Picture 17):

1. make sure all outriggers are raised off the ground;
2. make sure the basket block pin is inserted;
3. make sure the booms are returned and on their support;
4. turn on the machine (par. 3.1);
5. switch on and link the radio control;
6. use the joysticks **J1** and **J6** (Picture 17) to drive the tracks;
7. position the speed selector **SS** (Picture 17) on "turtle" symbol; move it to "hare" symbol (*optional) to increase the speed of the tracks or to "double hare" (*optional) to reach the maximum speed;
8. keep a safe distance from the machine of at least 3 m during traveling.

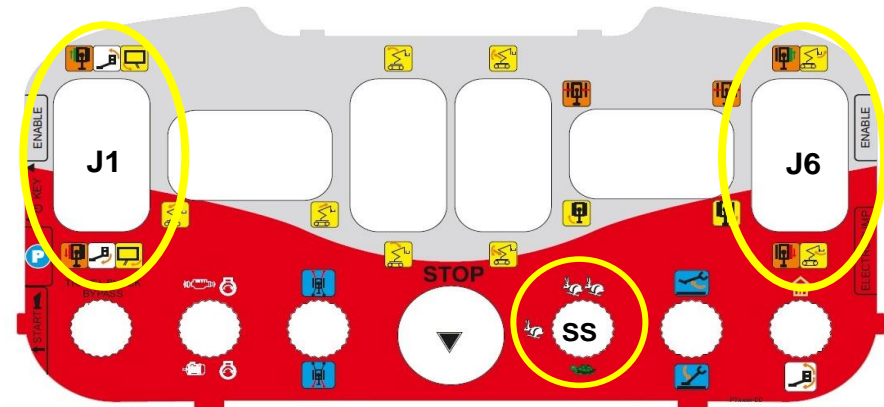

Picture 17: travel commands on radio control station.

! **WARNING!** The S23 machine can travel on a maximum inclination of 17° (31%), using only the radio control.

During travels, when reaching a 14° slope, an intermittent acoustic warning will activate; it becomes a fixed acoustic signal at 17°, in order to indicate the **PROHIBITION TO KEEP ON INCREASING INCLINATION FURTHER**. If the operator continues, reaching max allowed level (17°), the machine will inevitably go into total block.



☞ Procedure for bypass of travel block:

It is possible to bypass this block ONLY THROUGH OPERATIONS UNDER THE FULL RESPONSIBILITY OF THE USER, that can proceed as below:

1. move upward the lever **7** (Picture 8b), placed on the left downside of the radio control;
2. travel the machine using joysticks **J1** and **J6** (Picture 8b).

The bypass, at this point, will be active and the operator will be able to take the machine back to the conditions prior to the block (travel in the original direction), until stopping the previously activated acoustic warning.

C.M.C. DECLINES ANY TYPE OF RESPONSIBILITY TO THE OPERATOR. THE MANUFACTURER HAS CLEARLY ESTABLISHED TWO ACOUSTIC WARNING THRESHOLDS, IN ORDER TO FULLY INFORM THE USER ABOUT THE DANGERS DUE TO THE NON-RECOMMENDED ACHIEVEMENT OF TRAVEL SLOPE LIMIT.

4.4 ▶ MEWP operation procedures

The machine is equipped with the "SCS System" (Self Control System) which allows:

- automatic stabilization,
- automatic speed control,
- automatic closing of the aerial part.



The following procedures shall be carefully carried out in the correct chronologic order.



If full lithium version (*optional), before any work start, check the battery charge level. It is necessary to have at least 75% of battery charge, otherwise it is advisable to charge them before working.

4.4.1 ▶ Placement on the working area

1. Start the endothermic/electrical engine using the supplied engine ignition key (Picture 4);
2. identify the working area, which is nearest to the working place;
3. make sure the soil bears the load of the outriggers and check that there are no manholes, floors or other soft structures in the contact point of every stabilizer plate with the ground;



In case there are not such conditions, it is strictly forbidden to use the MEWP.

4. place the MEWP on the chosen area, using travel commands on radio control (par. 4.3.2.1);
5. define the working area with appropriate signals (white-red ribbon, white-red chains, cones, etc.).

4.4.2 ▶ MEWP stabilization

The MEWP has different stabilization areas, according to the different combinations of possible stabilizer openings. Each of four outriggers can be positioned in two different configurations (in addition to the closing one), corresponding to the following stabilization areas (see par. 1.1).

- a. narrow (4 feet closed);
- b. long (4 feet opened),
- c. mixed (2 feet closed, and 2 feet opened).

A double electronic locking system uniquely ensures the chosen working configuration.



The movement of the outriggers must be possible only when the booms are resting on their supports. This condition causes the light up of the stabilization consent light **8** (Picture 4) on the ground control station.



6. Lift the 4 pins which block the outriggers position (Picture 18). If this operation results difficulty, move the stabilizer trying to rotate it in the horizontal plane during the lifting.



It is forbidden, and unnecessary, to completely remove the pins from their seat.



Picture 18: outrigger pins.

7. with the pin lifted, rotate the outrigger taking it in a position which allows the reinsertion of the same pin. For each outrigger, it will be possible to choose two positions (1 and 2): the position taken by the outriggers determines the working area.
8. once reached one of the two outrigger positions required, push the pin downward until blocking it.
9. repeat these operations for all the stabilizers.



Check the cleanliness and the integrity of the limit switches attached to the stabilizers (sliders, brackets, springs and so on).

4.4.2.1 ▶ Manual stabilization from outriggers control station

The hydraulic distributor in Picture 13, present on the frame, allows to perform manual stabilization/destabilization of the machine.

▶ To facilitate stabilization of the machine, it is good to widen the tracks (*optional) beyond the shape of the frame. They are adjustable in width.

In order to activate the outriggers control station, it is necessary to:

9. keep the red button (dead man) SB pressed, located at left side of emergency button (Picture 13), during the levers handling;
10. lower the levers **1**, **2**, **3**, **4** (Picture 13).



IT IS ESSENTIAL TO CARRY OUT THE STABILIZATION OPERATIONS BY OPERATING ON ALL FOUR LEVERS SIMULTANEOUSLY. Once the feet will all have touched the ground, it will be possible to continue running short alternate cycles before on the two front stabilizers and then on the two rear ones.



Verify that the maximum slope to stabilize not exceed 13° (23%).

The machine will be correctly stabilized when the consent indicator for the use of the aerial part **7** (Picture 4) will light up. To achieve this condition, it is strictly necessary to lower the outriggers until they are well positioned on the ground, the tracks uplifted and the frame in planarity with a maximum tolerance of 1°.

4.4.2.2 ▶ Automatic stabilization with radio control

If you want to stabilize the machine in automatic mode, you can use the radio control:

- use the lever **11** (Picture 8): it causes the simultaneous descent of the four outriggers until the system reads the four limit switches for the ground contact and the lifting of the tracks;



- make sure that the consent indicator for the use of the aerial part **7** (Picture 4) is on.

During stabilization phase, pressing the parking button **P** (Picture 8) on the radio control, together the stabilization lever, you can raise all the machine without waiting the predefined cycle of automatic stabilization.

4.4.3 ▶ Access in the basket



Verify the correct assembly (Picture 19) of the basket to the jib: pivot and cotter pin inserted on the right side of the jib; pin turned to the right, up to basket edge on the left side.

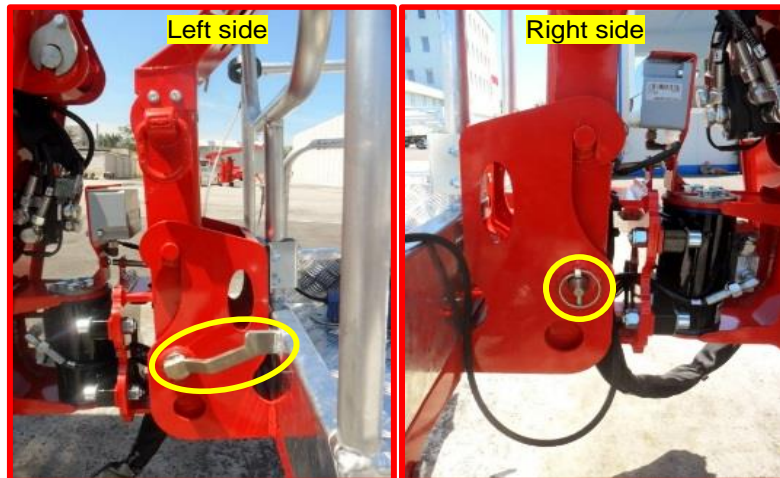

Picture 19: basket assembly.

11. Enter the basket by lifting the self-locking closing bar and using the underlying step;
12. **ensure that the bar is back to the closing position; fasten the safety harness to the proper safety anchorages in the basket frame.**



It is forbidden to overload the basket exceeding its maximum allowed nominal capacity.

4.4.4 ▶ Basket levelling

13. After making sure the stabilization consent light **8** (Picture 4) is on, level the basket using the platform control (operating) stations (par. 3.1): lower the dead man lever **12** and simultaneously move the joystick lever **J1** (Picture 8) for basket leveling control, in case the basket floor is out of level.



Carry out the basket levelling only when the MEWP aerial part is in transport configuration.



It is strictly forbidden to level the basket with the machine developed.

4.4.5 ▶ Use of the aerial part

14. After making sure the aerial part consent light **7** (Picture 4) is on, using the platform control (operating) stations, carry out the MEWP aerial part operations by the manipulators described in the paragraph 3.2.1.



First lift the booms, in order to rise it from the support.



It is strictly forbidden to rotate the turret as first movement, since it could seriously damage the carpentry.



It is forbidden to enter or exit the work platform at different levels, when the machine is developed.



It is forbidden to increase the outreach or working height of the MEWP by using additional equipment.



It is forbidden to use the MEWP as a lifting device.



Avoid contact of the aerial part with fixed objects (buildings, etc.) or with moving objects (vehicles, lifting equipment, etc.).

4.4.5.1 ▶ Moment limiter (*optional)



Thanks to a moment limiting device (anti-tipping device fitted as standard on this MEWP), all operations bringing the machine over the working diagram are ineffective.

When the maximum allowable outreach is almost reached (90%), the pre-alarm indicator **7** lights up (Picture 9).

When the maximum allowable outreach is reached (see the working diagram in Picture 2), the alarm indicator **15** lights up (Picture 9) and boom lifting/extension operations are blocked.

4.4.5.2 ▶ Load limiter (*optional)



Moreover, when the MEWP exceeds its maximum permitted capacity (200 Kg/441 lb.), the logic system detects the overload and stops the work operations, warning with a continuous acoustic signal.

During the movement of the MEWP aerial part, reaching the maximum load selected, the load limiter safety device activates:

- Overload until 20 Kg (signaled by the lighting of the intermittent block light **23** – Picture 9 and by an intermittent acoustic warning): in this case, operations remain active, even if these two signals warn the user about the danger; the signals will stop only removing the overload from the basket.
- Overload > 20 Kg (indicated by the fix lighting of the block light **23** – Picture 9 and by a continuous acoustic warning): the load limiter safety device stops all operations of the extendable structure.



The operator must remove the overload from the basket to continue the work with the MEWP.



It is strictly forbidden to use the MEWP when the load limiter warning is on. Remove the exceeding load from the basket until the acoustic signal and the relative light go out.

4.4.5.3 ▶ Slowdown of the aerial part maneuvers

Slowdowns can be set by software for start and end of each aerial part maneuver (lifting/lowering of arms, extension/retraction of arms, clockwise/ anticlockwise rotation of the turret, opening/closing jib), valid in the following conditions:

- Arm angle >x° or <x°;
- Arm extension >x mm or <x mm;
- Opening jib >x mm or <x mm;
- Pre-alarm condition (90% of the block);
- Approaching the turret angle to a curve change zone.

4.4.5.4 ▶ Anti-crash system

When the machine is stabilized in the predefined areas, both with tracks resting on the ground and raised, the stabilizers with their curved structure can reach a height greater than that of the machine frame.

Furthermore, the engine pack with the fuel tank has a considerable bulk, which comes out from the rear shape of the chassis.

The anti-crash system, supplied as standard device, does not allow the aerial part (pantograph, boom, jib) to have accidental impacts with these bulky parts mounted on the frame and the stabilizers, blocking the movements operated by means of logic parameters set via software.

When activated, it is signalled by the warning light **6** (Figure 9) on the electronic panel of the radio control or wired remote control.



When the warning light **6** will be flashing and will be associated with an audible alert, the machine will be in "anti-crash block" (collision danger). In order to unlock the machine, it is necessary to press the



parking button **P** on the radio control together with the desired manoeuvre.

If, during the descent of the pantograph or booms, the machine gets blocked (anti-crash warning light on), it will be necessary to continue the closing operations by pressing and holding the parking button **P** simultaneously to the desired operation. The sudden or intentional release of that button will immediately disable the operation carried out.

4.4.6 ▶ Setting the MEWP in the transport configuration

15. In order to set the MEWP in the transport configuration, first center the turret, return on the ground the aerial part, withdrawing the telescopic booms, and laying the booms on their supports, using the platform control (operating) station (par. 3.2.1).

Alternatively:

- a. Keeping the parking button **P** (Picture 8) pressed on radio control, together the **J5** joystick which control the turret rotation, you can activate the turret self-centering up to the position 0°.
- b. With the MEWP stabilized, pressing the parking button **P** (Picture 8) on radio control, it is possible return the booms.



Warning! Center the turret before lowering booms.

16. With machine stowed, unfasten safety belts and get off the basket using the ladder steps below.

17. In order to destabilize the machine, from the ground:

- In case of manual destabilization, keep the dead man button pressed and use the levers of the outriggers control station (Picture 13).



It is essential to carry out the destabilization by operating on all four levers simultaneously.

- If you want to automatically destabilize the machine, use the parking button **P** and the lever **11** (Picture 8) on the radio control.

18. At the end, it is possible to restart the MEWP to take it back to the storage place by radio control station.



If full lithium version*, at the end of the work, always remember to charge batteries.

4.4.7 ▶ "Home" function



The following procedure should be carried out with the most caution and wearing all personal protective equipment.

This function is very useful at the end of works to set the platform in transport configuration.

When the appropriate button (dead man) "Home" **12** (Picture 8), present on the radio control station, is held pressed, the automatic closing of the aerial part is activated.



The following maneuvers must be carried out up to the limit switches in order:

- boom return up to 0°;
- turret rotation in the original direction up to 0°;
- pantograph descent up to 0°;
- boom lowering up to the support.



CAUTION! IF YOU MEET OBSTACLES DURING THE AUTOMATIC CLOSURE OF THE MACHINE, IMMEDIATELY RELEASE THE BUTTON AND PROCEED WITH THE MANUAL MANOEUVRES.

4.4.8 ▶ Acoustic warnings

During the use of the MEWP, it is possible to hear the following acoustic warnings (*optional), corresponding to the following signals:



🔔 SOUND	Corresponding to:
Continuous acoustic signal (intermittent in pre-alarm): when exceeding the maximum travel inclination allowed.	Maximum travel inclination light activated on basket control station and on wired remote control.

Table 3: acoustic signals.

4.5 ▶ Lithium battery pack recharge (*optional) ◀

For full lithium version (*optional), in order to recharge the battery pack, it will be necessary to stall the machine.

Then operate according to the following procedure:

1. switch off the electric engine;
2. couple the 110/120/230 V plug (power line) to the connector on the machine and press the appropriate button of the magnetothermic switch;
3. now the batteries will be in charge and the charge progress can be evaluated through the leds on chassis box or on radio control station.



The charge times are:

BATTERY CHARGE	TIME
0% - 80%	4 h
80%-100%	2 h

With a full charge (100%), the 160 Ah battery pack is able to perform at least 10 work cycles. A work cycle includes the following sequence of operations:

- 1) stabilization;
- 2) complete machine development;
- 3) complete machine return;
- 4) destabilization.



At the end of each working session and however at least every 15 days, if the MEWP is not used, absolutely recharge the battery pack.

4.6 ▶ Emergency manoeuvres ◀



Before starting the emergency procedures, it could be useful to contact C.M.C. Service and communicate errors data.

In case of emergency, the controls of the MEWP aerial part can be performed by the operator on the ground.

4.6.1 ▶ Emergency buttons

In case of emergency, push the emergency button EB: the MEWP engine switches off and all operations are disabled. This button has priority over all other commands.

The emergency button has a mechanical locking device, therefore, to restore normal working conditions, it must be unlocked by turning it clockwise.

On the machine, there are emergency buttons in the following positions:

- on the radio control station (Picture 8);
- on the basket command station (Picture 12);
- on the left side of outriggers control station (Picture 13).



In order to secure the machine, perform the following procedures in the chronological order indicated:

1. recovery of the aerial part;
2. closing of the stabilizers;
3. retraction (*optional) and travel of the tracks.

4.6.2 ▶ Emergency bypass

In case the basket operator pressed the emergency button and were unable to reset this button at the original position (due to blackout, fainting or other), it will be possible to disable that safety function through **the “emergency bypass”** (Picture 4) covered by a yellow cap and located on the left of the switching on/off box.

The ground operator removes a safety lead seal and disable the emergency through an internal on/off lever.



It will be care and responsibility of the operators, at the end of the operations, to reset the original conditions, including the resealing with seal compulsorily branded “CMC”.

4.6.3 ▶ Failure of hydraulic system

In case of emergency (fuel run out and/or breakage of a hydraulic component, endothermic power failure, etc.), to obtain pressure inside the hydraulic circuit, necessary to the movement of the MEWP’s components, you can use the auxiliary electric engine (*optional) or the electropump (*optional), if installed, activating it as described in paragraph 4.5.6.

Once they are started, carry out the recovery operations through the emergency control station (Picture 15).

In case of their absence, the manual pump can be used for emergency recovery of the MEWP.

4.6.4 ▶ Failure of electric system

In case of electrical system failure, to obtain pressure inside the hydraulic circuit and to perform emergency recovery of the MEWP, it is necessary the presence of two operators and the use of manual pump.

4.6.5 ▶ Simultaneous failure of hydraulic and electrical system

In case of simultaneous failure of hydraulic and electric system (hydraulic system failure if not available electropump, or simultaneous failure of the hydraulic and electrical system), to obtain the pressure inside the hydraulic circuit, you can use the manual pump.

The manual pump lever must be inserted in the appropriate position shown in Picture 20, at the right side of the emergency control station.



Picture 20: manual pump insert.

Recovery of the aerial part:



First carry out the recovery operations of the aerial part, to make the basket operator safe.

1. Turn the manual pump tap (Picture 21) on the position represented by the platform symbol (fully to the bottom).

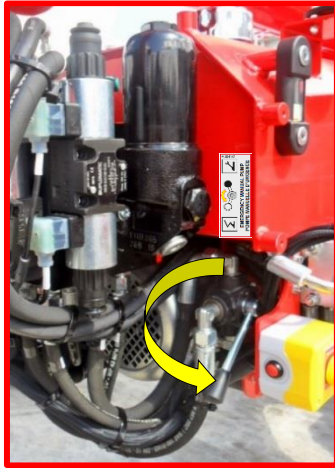

Picture 21: tap for manual pump use.

2. Unseal and fully screw the black knob of the tap **LFT** (Picture 22) at the left of the filters bench.

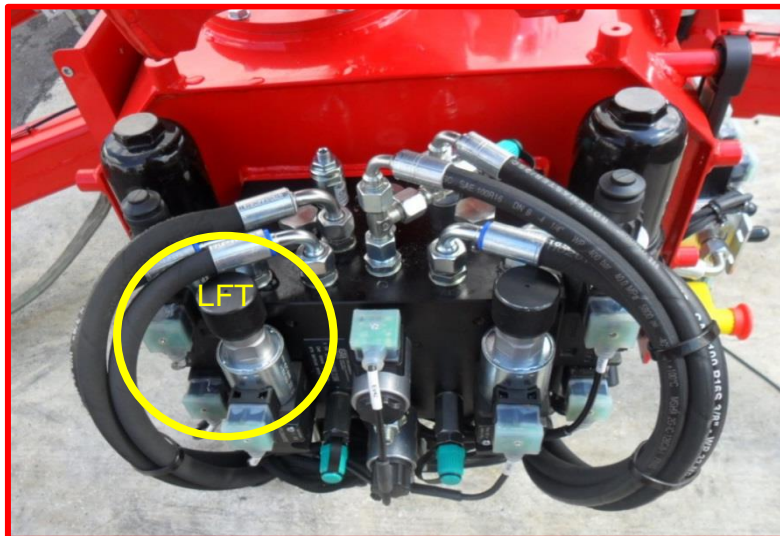

Picture 22: left tap of filters bench.

3. Unseal and screw (fully to the right) the black knob of the proportional valve **PV** (Picture 23a) of the emergency workbench.

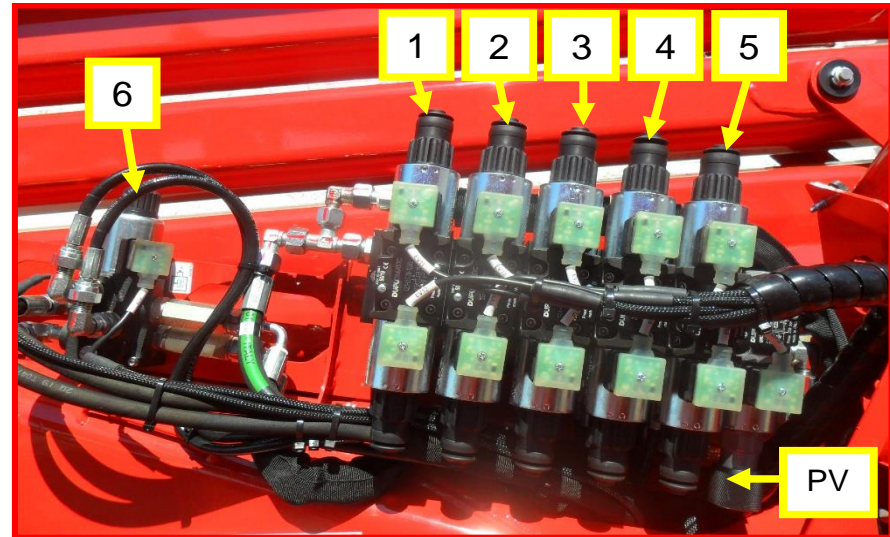

Picture 23a: emergency workbench.

4. Perform the aerial part recovery operations in the following sequence, by pressing the cursor of the specific maneuver (Picture 23a) and simultaneously pumping oil with the manual pump:
 1. jib closing **5**;
 2. telescopic booms return **2**;
 3. telescopic booms lowering **3**;
 4. pantograph lowering **4**;
 5. basket levelling **1**;
 6. turret rotation, keeping pressed **6** together **1**.



CAUTION!! In case of emergency, first perform the retraction of the telescopic boom and then the lowering of the boom and of the pantograph.

If the MEWP is equipped with a moment limiter device (*optional), the emergency workbench looks like in Picture 23b.



Picture 23b: emergency workbench in case of moment limiter device (*optional).

! In case of moment limiter device (*optional) supplied, for all aerial movements described above, it will be necessary to unseal and keep pressed, in the meantime, the red cursor of the solenoid valve R located in the turret (Picture 23b).

! If necessary, the basket operator can operate:

- the basket centering, pressing the valve cursor placed on jib (Picture 24), with a pointed object;
- the basket rotation, pressing the valve cursor placed on jib (Picture 24) and another ground operator keep pressed the cursor 5 on emergency workbench (Picture 23a).

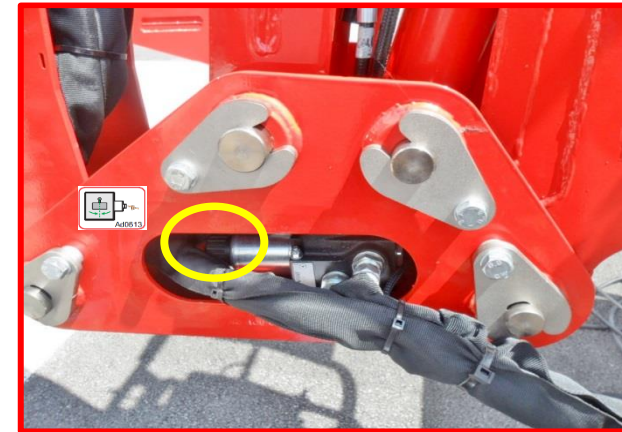

Picture 24: valve cursor for basket centering/rotation.

! While return the MEWP in rest configuration, the deceleration ramps of the maneuver speeds will be inactive: therefore, pay particular attention to the operations wearing all personal protection equipment provided by law.

! At the end of aerial part recovery, it is possible to get the operators off the basket.

! At the end of these operations, return the valves to their original state.

Recovery of the stabilizers and retraction of tracks:

1. Turn the manual pump tap (Picture 25) on the position represented by the stabilizers symbol (fully to the top).

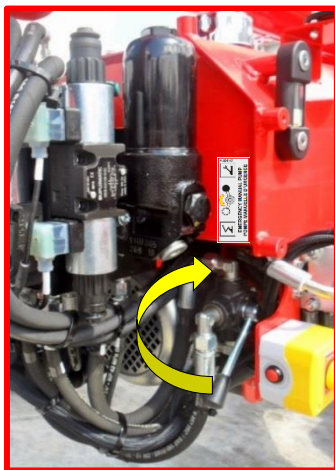

Picture 25: manual pump tap to be turned to the top.

2. Unseal and fully screw the black knob of the tap **RFT** (Picture 26) located at the right of the filters bench.

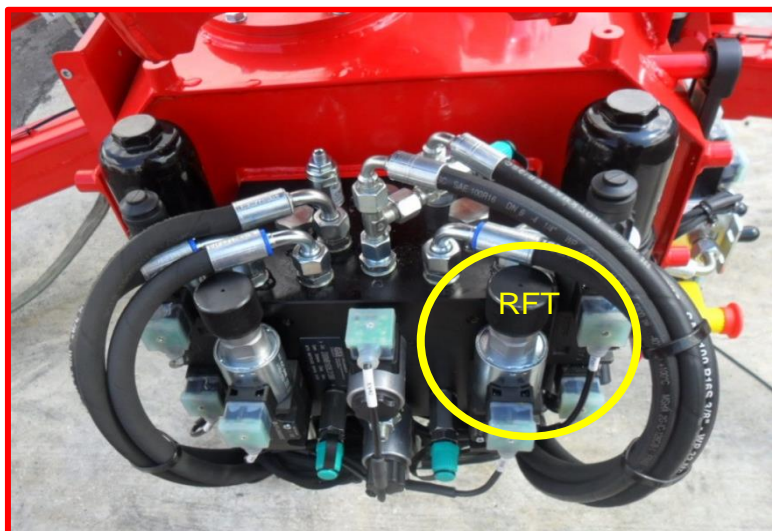

Picture 26: right tap of filters bench.

3. Unseal and screw (fully to the right) the black knob of the stabilizers valve **SV** (Picture 27), placed at the right side of the outriggers control station.

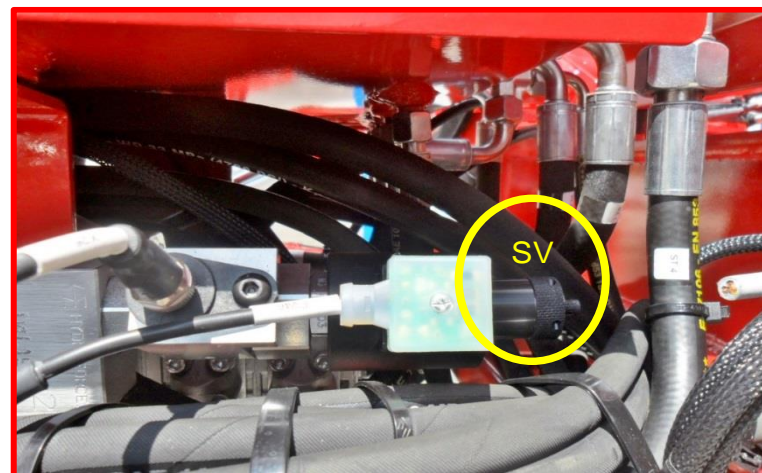

Picture 27: stabilizers valve.

While pumping oil with the manual pump:

4. Perform the stabilizers retraction through the levers **1, 2, 3, 4** of outriggers control station (Picture 13).
5. Execute the tracks re-entry (*optional) moving upward the lever **5** on outriggers control station (Picture 13).



It is strictly forbidden to use the MEWP with solenoid valves tampered or without seals.



It is mandatory to restore the sealings after use of these items.



AFTER THE RECOVERY OF THE PLATFORM BRING THE MEWP TO C.M.C. OR TO AN AUTHORISED WORKSHOP FOR THE RESTORING OF THE NORMAL OPERATING CONDITIONS WHICH ARE INDISPENSABLE FOR THE SAFETY OF THE MACHINE.

4.6.6 ▶ Electropump (*optional)

The 12 V emergency electropump (Picture 28) is a source of alternative energy for the engine and should only be used in case of emergency.



ANY DIFFERENT USE IS ABSOLUTELY NOT RECOMMENDED. IN FACT, THE ELECTRIC PUMP, BY ABSORBING POWER DIRECTLY FROM THE BATTERY, CAN PRODUCE THE UNEXPECTED DISCHARGE OF IT.



Picture 28: electropump.

It can be activated by:

- **button** (Picture 29) on the right side of the radio remote control;
- **lever** (Picture 29) under the red sealed cap on the left side of switching on/off box.



To activate the emergency electropump from the switching on/off control station, it will be first necessary to remove the seal on the red cap, lift it and then press the black lever below (Picture 29).



Picture 29: electropump activation buttons.



In case of emergency, switch on the electropump, repeat the emergency maneuvers described above, after turning the electropump tap (Picture 30), placed at the left of filters bench, first to the top to recovery the aerial part and then to the bottom to recovery the stabilizers.



Picture 30: electropump tap.



4.7 ▶ Safety rules ◀



THE NON-COMPLIANCE WITH ANY OF THE FOLLOWING SAFETY RULES, MAY CAUSE SERIOUS DAMAGES TO PEOPLE, THINGS AND PARTS OF THE EQUIPMENT OR THE MACHINE.

4.7.1 ▶ Before and during the movements with MEWP in transport position



It is forbidden to rent the MEWP without non-trained operators and staff.

➔ The hirer is responsible for the training of his operators and of the staff renting the MEWP. C.M.C. s.r.l. declines any responsibility coming from damages to people and/or things due to the inexperience of these operators;



Do not use the MEWP under drug or alcohol effect;



Do not use the MEWP under stress conditions;



Do not use the MEWP if you suffer from dizzy spells;

➔ Before driving, check the tires wear state and the correct inflation pressure;

➔ Drive with caution, respecting the highway code;

➔ Take the MEWP height overall dimensions into consideration during circulation, in order to avoid clashing against bridges, galleries, underpasses and other obstacles;



Do not use the MEWP to perform drawing or pushing operations;



Do not use the MEWP as an off-road vehicle;

4.7.2 ▶ Before positioning the MEWP

➔ Carefully and chronologically follow the instructions given in this manual;



Use the MEWP only with the environmental operating conditions indicated in paragraph 4.1;

➔ **Check that the staff allowed to use the MEWP is skilled and trained, and that they know the MEWP use and maintenance rules;**

➔ Check that the safety devices are working and efficient; some components (outriggers integrated groups, max pressure valve on the turret), important for the MEWP safety, are calibrated in C.M.C. plants and the containers are sealed before delivering of the MEWP to the customer.



It is strictly forbidden to tamper with such components. The absence of the sealing within the machine warranty terms causes the immediate retraction of the warranty as well as the accountability – by the user – of the liabilities coming from an incorrect functioning of the safety devices.



Do not remove or modify safety devices;



It is forbidden to modify, remove or replace any MEWP component (ballasts, tires, batteries, spare tire etc.): this operation could reduce the machine weight thus impairing its stability;

➔ Wear all the protective cloths and the personal safety devices: helmets, safety shoes and - according to the type of work - gloves, hearing protections, respirators, etc.;



Do not use clothes with hanging flaps, scarves, ties or any other accessory which could be dragged into the moving parts; inform about the closest fire-extinguishers and first-aid kit.

4.7.3 ▶ During the positioning of the MEWP



It is forbidden to operate in situations which are dangerous for the safety of people;



Do not operate in explosion hazard areas;

- Check that the working area is suitable to the MEWP performances and operations, and that it is enough lit;
- Check that the operational stands and the working area are enough lit and well visible;
- If operating in closed or little aired environment, ensure, before starting the machine engine, that this has appropriate ventilation or convey exhaust gases outside:



Exhaust emissions produced by the MEWP engine are toxic;

- Appropriately define the working area through suitable signs; observe the laws in force about the traffic, in case you use the MEWP where road circulation is allowed;
- Check that nobody is within the MEWP action range.
- Stabilize the truck through the outriggers.



Pay the utmost attention during stabilization: check that no one is inside the stabilization area.

- Check that the outriggers rest on a non-soft, solid ground that bears the load indicated on each stabilizer.
- In case of soft ground, use supporting plates.



It is forbidden to place the outriggers on ground roughness: they could be damaged.

- Level the machine in order to let the MEWP operate on a horizontal plane: max frame fall 1° - max slope which can be assimilated by the ground 3°.

4.7.4 ▶ During the entrance in the basket



It is absolutely forbidden to use the equipment with loads different from those indicated on the diagram or for uses which are not allowed;



Do not overload the MEWP;

- **During the different working operations, the use of the safety belts is compulsory.** Do not fasten the safety belts to external structures but only to the supplied grips placed in the basket;
- Make sure that the bar lifted to enter the basket, has returned in its lock position.

4.7.5 ▶ During the use of the MEWP

- In any dangerous or irregular conditions, stop the machine by using the emergency button. Before restarting the machine, check that the dangerous conditions are over;



It is strictly forbidden to level the basket when the machine is in working position;



Do not operate when the MEWP is in failure;



It is forbidden to use the “platform control (emergency) position” when there are operators inside the basket, unless there is emergency or for testing operations before starting the work (which shall be carried out without anyone in the basket): from downstairs, it is difficult to estimate how far the basket and the MEWP structure components are from possible obstacles;

- Follow the MEWP working diagram;



It is strictly forbidden to use the platform as a crane, to hang posters, banners, poles, etc. to the basket or to any other part of the MEWP.;



Do not connect chain or ropes to the MEWP (since they could be trapped amongst the MEWP moving parts or they could hook fixed objects thus causing the machine overturn);



















It is absolutely forbidden to lift or lower loads by using ropes and pulleys;



It is forbidden to lean out;



-  It is forbidden to use the MEWP for recreational purposes;
-  Do not perform the basket rotation operation together with other operations;
-  No material shall fall from above: fasten the working material properly;
-  Do not throw objects (tools) upside down or vice versa.
-  In case of works like pruning, plants maintenance, etc., it is forbidden to let trunks, pipes, poles etc. fall inside the basket or on the MEWP structure: they can severely impair the MEWP stability;
- ➔ During works like paintings, etc., protect yourselves and the machine;
-  It is strictly forbidden to put tools, body parts in the areas marked by the stickers indicating crushing, shearing hazard; keep manuals away from any hole or slit;
-  It is forbidden to use tools not complying with the laws in force;
- ➔ When working at low temperatures, it is necessary to perform some in-vain operation so that the hydraulic circuit oil reaches the operating temperature;
-  It is forbidden to let people walk or stay within the MEWP working area;
-  It is forbidden to stay on the counter frame floor, during MEWP operations.
- ➔ Firmly cling to the work platform during lift and descent;
- ➔ Controls shall be started by slow and gradual movements:
-  Do not operate controls swiftly and suddenly

-  It is forbidden to make the platform swing;
- ➔ Check the MEWP stability during all the operations phases;
- ➔ Do not move the MEWP during the working operations;
- ➔ Keep enough safety distance from the obstacles: avoid contacts with fixed (buildings, etc.) and moving (vehicles, cranes, etc.) objects, with the truck cabin, with the outriggers and with other structure parts;
-  It is forbidden to use ladders or tables on the basket in order to increase the MEWP outreach or working height;
- ➔ Be careful when working in close buildings: due to the “wind tunnel” effect, sudden blasts could cause swinging, thus impairing the machine stability;
-  It is forbidden to lift “full surface” panels (signs, advertising panels, boards, etc.): these could cause the “sail” effect;
-  It is forbidden to leave the MEWP unattended when it is in working position;
-  It is forbidden to exceed the max number of basket operators allowed;
-  During the normal use of the platform, it is absolutely forbidden to use electronic instruments which do not meet the requirements of the directive 72/245/CE and its following amendments: the additional electronic instruments could impair good functioning of the platform electronic components.

4.7.6 ▶ At the end of the works

- ➔ Before moving the machine, check that the MEWP aerial part is set in the transport position: check that the pantograph is on its own support, that the telescopic boom is withdrawn and rests on its own support;
- ➔ Before moving the machine, check that all the outriggers are completely withdrawn and blocked, that they are set in the transport position, with the plates completely lifted.



4.8 ▶ Safety devices ◀

A - Electrical devices

- Removable key for the ignition from the chassis.
- Emergency stop buttons on the two control stations.
- Basket levelling manoeuvre only allowed when the MEWP aerial part is in rest position (telescopic boom on its support).
- Microswitch blocking the outriggers controls with booms lifted and if the extension is not in withdrawn position;
- Microswitch for outriggers end-of-stroke;
- Protection fuses against brownout, both on the power circuit and on the control circuit;
- All machine controls hold-to-run;
- Emergency buttons in the control stations.
- Interlock stabilizers-boom manoeuvre:
 - block of the manoeuvres of the MEWP aerial part when this is not stabilized;
 - block of the manoeuvres of stabilizers return/extraction when the MEWP aerial part is not in rest position.
- Warning light - machine stabilized.
- Warning light - electrical supply of the MEWP.

B - Hydraulic devices

- Maximum pressure valves for the protection of the entire hydraulic circuit and the individual parts of the system.
- Block valve and parachute valve mounted on the lifting cylinders.
- Manual pump for emergency operations.
- Oil flow regulator for the control of the descent speed.

C - Mechanical devices

- Hydraulically controlled negative disc brakes.
- 1,10 m height border guardrail on the basket.
- Mobile bar for access to the basket with gravity closing.
- Basket with safety belts connections.
- Mechanical blocking system of turret rotation.
- Limit switch stop-lowering boom.
- Limit switch boom centring.
- Limit switch stabilizers opening.
- Limit switch boom lifting-lowering in parking position.



All safety devices could wear out and lose their calibration, it is therefore necessary to control and keep them in perfect working order.



Do not rely totally on these devices to assess your working and safety conditions; in any case, the operator must have a proper and conscious use of the machine.



5 ▶▶ Markings ◀◀

On the machine there are the following marks.

- ➔ Before using the MEWP, it is compulsory to check the presence and the perfect readability of these marks. In case of absence or decay of the marks, contact the Service.

 C.M.C. s.r.l. Via Bitritto, 119 70124 BARI - ITALY Tel. 080 5326606/557 http://www.cmclift.com E-mail: info@cmclift.com				 	
TYPE	S23	MANUFACTURER	C.M.C.		
MODEL	S23	YEAR			
SERIAL NR.		TOT. WEIGHT	lbs		
CAPACITY	441 lbs	INCLUDING	2 persons		
MAX HYDRAULIC OPERATING PRESSURE	3336 PSI				
MAX MANUAL HORIZONTAL FORCE ALLOWED	90 lbs				
MAX WIND SPEED ALLOWED	28 mph				
MAX FRAME INCLINATION ALLOWED	1 °				
EXTERNAL POWER SOURCE	230 V		50 Hz		

Picture 31: identification plate (fac-simile).

cmcXS23

Picture 32: MEWP mark.

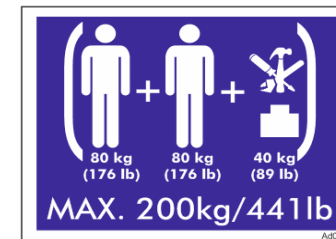

Picture 33: maximum load in basket.

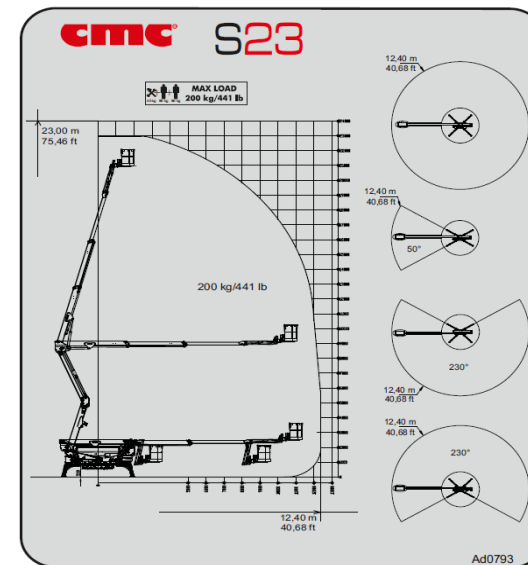

Picture 34: work diagram.

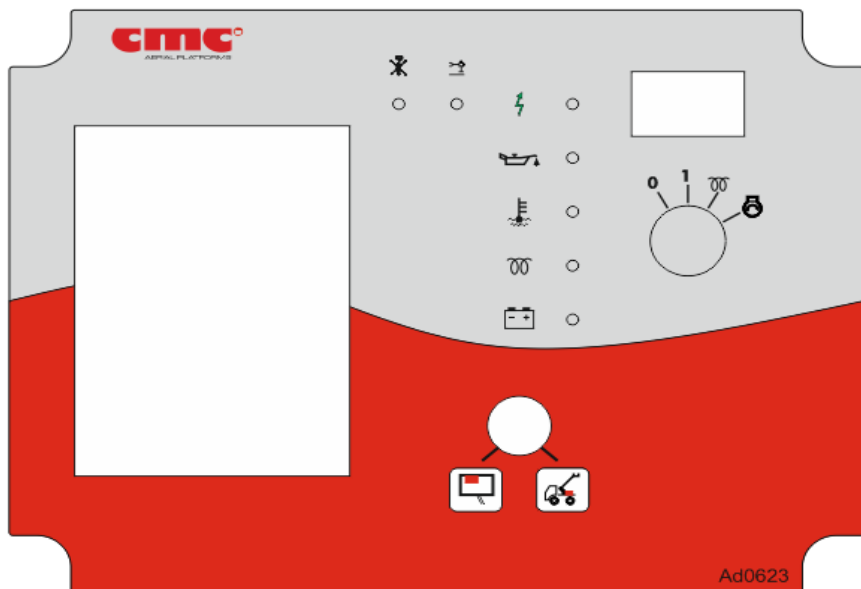

Picture 35a: switching on/off box in case of diesel engine.

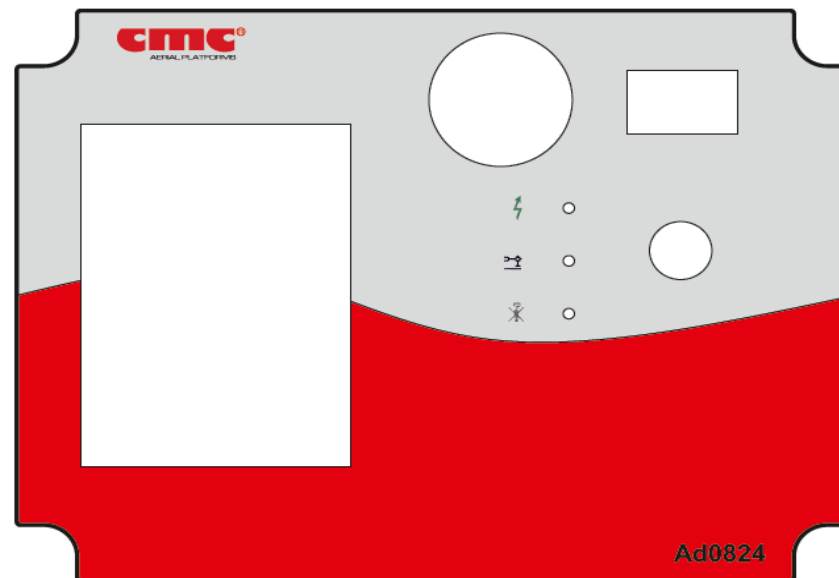

Picture 35b: switching on/off box in case of full lithium version.

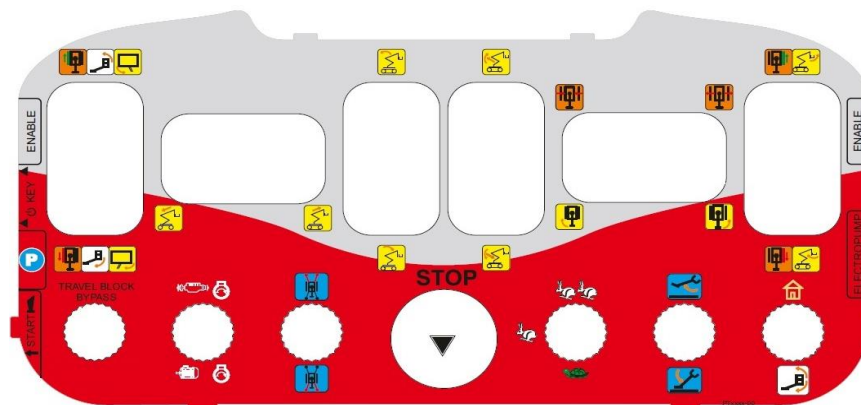

Picture 36: AUTECH radio control station.

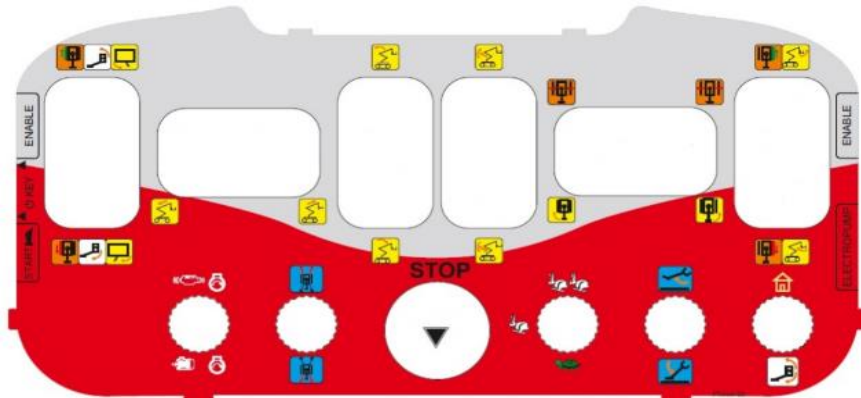

Picture 37: ATEC wired remote control station.

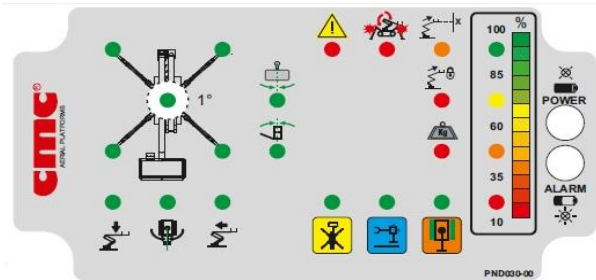

Picture 38: ATEC electronic panel of radio/wired control station with battery charge indicator*.

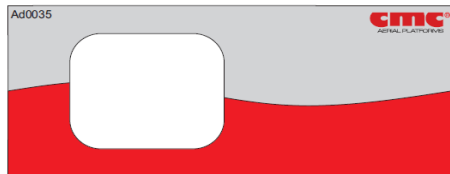

Picture 39: display box.

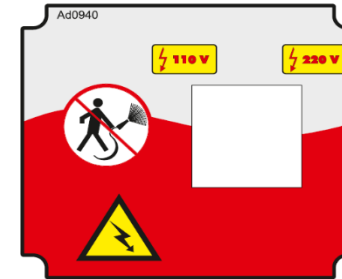

Picture 40: dual power selector (*optional).



Picture 41: safety belt attachment point.



Picture 42: indication of air/water supplies.



Picture 43: indication of 12 V socket.



Picture 44: travel directions on tracks.

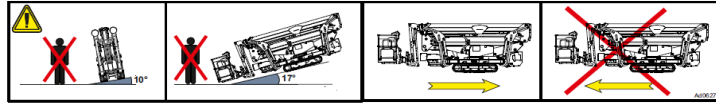

Picture 45: warning for machine travel, on left/right side of frame.



Picture 46: use and maintenance manual box.

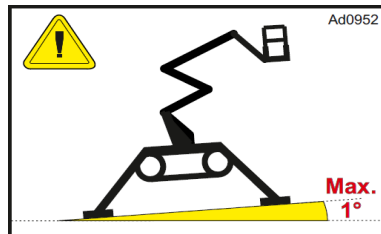

Picture 47: indication of maximum frame inclination.

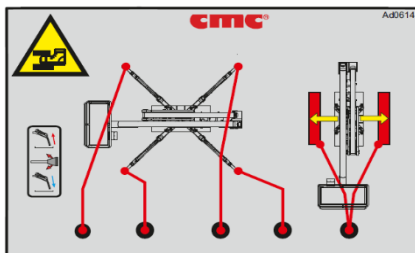

Picture 48: outriggers control station.

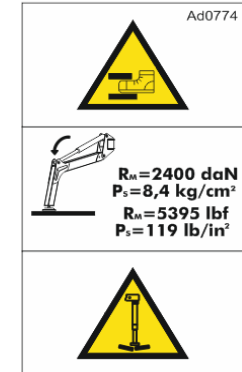

Picture 49: maximum load on stabilizers.



Picture 50: indication of outriggers limit switch.



Picture 51: prohibition to stand in work area.



Picture 52: prohibition to remove safety devices.



Picture 53: indication for fuel refill.



Picture 54: exhaust gas hazard.



Picture 55: danger of flammable substances.



Picture 56: indication for grease application.



Picture 57: indication for engine oil checking/refill.

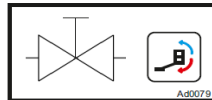

Picture 58: indication of basket levelling valves.



Picture 59: auxiliary electric engines (*optional).

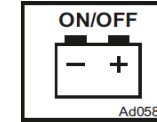

Picture 60: indication for engine battery disconnection.

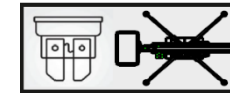

Picture 61: indication of platform fuse.



Picture 62: indication of frame coupling.



Picture 63: indication of fork points.



Picture 64: warning for basket operator fainting.

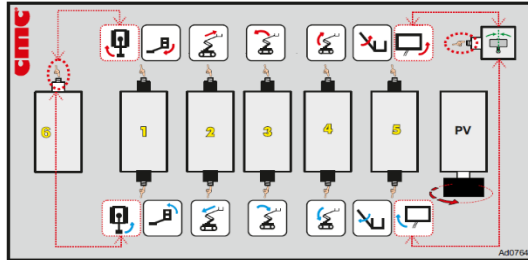

Picture 65: emergency station on turret.

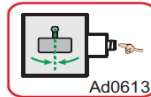

Picture 66: cursor for basket centring.

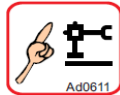

Picture 67: dead man button for stabilization.

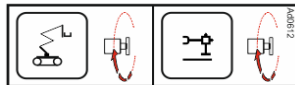

Picture 68: MEWP/outriggers workbench.



Picture 69: emergency bypass.



Picture 70: indication of emergency manual pump.

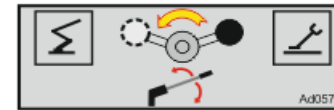

Picture 71: aerial part/stabilizers exchange tap in case of manual pump.



Picture 72: general obligations and prohibitions.

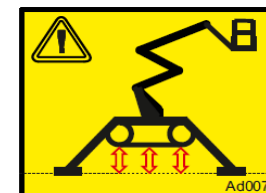

Picture 73: warning for tracks lifting during stabilization.



Picture 74: warning of burn risk.



Picture 75: earthing.



Picture 76: electric danger.



Picture 77: crushing and cutting hazard.



Picture 78: high pressure hazard.



Picture 79: danger of falling.



Picture 80: obstacle danger.



Picture 81: machine sound power.



Picture 82: prohibition to wet the machine.



Picture 83: warning to obligate to the consultation of use and maintenance manual.



**GUIDELINES FOR
USE AND MAINTENANCE**

- The use of the MEWP is restricted only to authorized and previously trained personnel.
 - Consult and comply strictly with the instructions indicated in **USE AND MAINTENANCE MANUAL** attached to the machine.
 - Never exceed the maximum capacity indicated on the basket.
 - The use of personal protective equipment is mandatory. In the basket, hook the safety belt to the appropriate anchors.
 - Before starting works, the operator must make sure that the mechanical parts and safety devices work properly and efficiently, and check the hydraulic oil and fuel levels.
 - Never stabilize the machine on soft, accidental, slippery ground or with slopes higher than the allowed limit.
 - Perfectly level the machine frame within the maximum allowed limit.
 - All handling maneuvers must be carried out making sure that you have complete visibility of the work area.
 - Before activating any movement, check that there are no obstacles or people in the work area.
 - Load and unload from the basket only on the ground.
 - It is forbidden to carry out works at a distance of less than 5 m from power lines.
 - It is forbidden to operate in unfavorable weather conditions.
 - It is forbidden to use the machine as a lift for things or people.
 - It is forbidden to fix stairs or other equipment to the basket to increase the working height.

Ad0137

Picture 84: MEWP use guidelines.

NOTICE/AVIS

Ad0020

THIS AERIAL WORK PLATFORM IS BUILT ACCORDING TO **US, ANSI 92.6 SECTION 4** and **CAN/CSA B354.4-02 (R2013)** about «Self-propelled boom-supported aerial elevating work platforms».

LA PLATE-FORME DE TRAVAIL AÉRIENNE EST FAITE SELON LES NORMES **US AINSI 92.6 SECTION 4** ET **CAN/CSA B354.4-02 (R2013)** «Plate-forme de travail aérienne avec élévation supportée par la flèche auto-propulsée».

Picture 85: compliance with ANSI and CAN/CSA rules.

NEXT INSPECTION
DUE ON:

DATE:

or
WORKING HOURS

Picture 86: inspection tag.

6 Electrical system

The MEWP is electrically supplied when the key is inserted and rotated in position 1 (Picture 4).

Periodically check the efficiency of the electrical system: battery, alternator, regulator alternator charge.

The electrical system is attached to this manual.



Any operation requiring interventions on the components of the machine, shall carried out by authorized and trained staff.



It is forbidden to replace the components for non-authorized staff. **Many components of the MEWP have been calibrated: a correct calibration of these parts (which is possible only in CMC or in authorized Services) is important to assure the safety of the machine.**

- **FUSE BOX (Picture 87):**

At view on machine switching on/off station, there is a fuse box where it is possible to find all the machine fuses. You can also identify the burnt ones through the lighting of a related led.



Picture 87: fuse box.

FUSE BOX	
Fuse 1	50 KEY (ENGINE START COMMAND)
Fuse 2	SPARK
Fuse 3	POWER CHASSIS COVER
Fuse 4	BASKET SENSOR POWER SUPPLY
Fuse 5	REM SOCKET 12 V
Fuse 6	TURRET AND BASKET POWER SUPPLY
Fuse 7	CHASSIS DEVICE POWER SUPPLY
Fuse 8	EMERGENCY LINE 15/54
Fuse 9	TURRET POWER SUPPLY
Fuse 10	STOP ENGINE

Table 4: fuse functions.



7 Hydraulic system

The MEWP hydraulic system is attached to this manual.

The pressure setting of relief valves must correspond to the following values:

Data	Value	Unit of measure
Inlet group - outriggers	225 (3263)	bar (psi)
Inlet group - platform	245 (3553)	bar (psi)
Boom descent valve	120 (1740)	bar (psi)
Outriggers distributor	220 (3191)	bar (psi)
Aerial part distributor	245 (3553)	bar (psi)
Basket levelling valve	140 (2031)	bar (psi)
Turret rotation valve	140 (2031)	bar (psi)
Pantograph descent valve	120 (1740)	bar (psi)
Jib lifting/descent valve	190 (2756)	bar (psi)
Basket rotation valve	190 (2756)	bar (psi)
Boom extension valve	200 (2901)	bar (psi)
Pressure relief valve of tracks	225 (3263)	bar (psi)



In case of its refill or replacement, it is imperative to comply with the technical specifications of the product already present in the hydraulic circuit.

A radiator for cooling the hydraulic circuit oil and a biodegradable hydraulic oil can be provided as *optional. In case of its refill or replacement, it is imperative to comply with the technical specifications of the product already present in the system.



All the operations requiring maintenance interventions on the components of the machine, shall be carried out by authorized and trained technical staff.



Many components have been specially calibrated: a correct calibration of these parts (only in CMC or in authorized Services) is necessary to ensure the safety of the machine.



8 Maintenance

Working in safety also means working with equipment in accordance with law standards and under constant control.

Then, the employer must:

- select proper equipment, adapted to the environment and working conditions and to the characteristics of the worker who implements it;
- supervise that it is used appropriately, and that specific training is provided to workers;
- ensure that the work equipment is:
 - installed and used in accordance with the use instructions;
 - subject to proper maintenance in order to guarantee the permanence of the safety requirements
 - subject to the update of the minimum safety requirements established with international specific regulations.

A correct use of the platform and a regular maintenance are crucial to keep it always in the best working, efficiency and safety conditions. The frequent washing of the equipment by high-pressure water jet machines is crucial to get rid of the harmful remains coming from the works performed and from atmospheric agents. Before washing, set the MEWP in driving position, stall the engine and take off the batteries.

To document what has been done, the employer is therefore required to draw up and update the appropriate equipment control register.



Carefully read and scrupulously follow the maintenance instructions and safety laws during the maintenance.

The operations indicated with **USER** are to be performed by the user. The operations indicated with **CMC** shall be performed only by C.M.C. srl or in authorized repair shops. Use only CMC original spare parts (even if on the market there are equivalent or similar parts).

The frequency of the maintenances is indicated in every table. It is implied a normal use of the equipment; while, for particularly rough uses or in harmful environments (presence of dust, sand, etc.), an optimal maintenance frequency is left to the good sense of the user.



If an intervention that is different from the following ones is necessary, ask the Technical Assistance Service for authorization and instructions.

8.1 Daily maintenance

Every day, before starting the MEWP, perform the following operations:





All the following checks are to be performed operating the MEWP from the emergency control station and without anyone inside the basket.





Inspections	In case of negative outcome of the checks:	Resolution by
Check the hydraulic oil level in the tank.	Refill it	USER
Check the level of fuel in the tank.	Refill it	USER
Check the coolant level .	Refill it	USER
Check the state of the batteries charge .	Recharge or replace them	USER
Check the cleanliness of the floor : oily or greasy residues could cause slipping.	Clean the surface	USER
Check that warning and instruction stickers on the MEWP are not damaged or missing.	Replace and/or integrate them	USER



Inspections	In case of negative outcome of the checks:	Resolution by
<p>Perform the following test maneuvers operating on the (emergency) controls of the cabled remote control when no one is on board:</p> <ul style="list-style-type: none"> ○ Lifting and lowering of telescopic boom 1; ○ Lifting and lowering of telescopic boom 2; ○ Lifting and lowering of the Jib; ○ Turret CW and CCW rotation; ○ Extension and withdrawal of telescopic arms. <p>THE BASKET FLOORS SHALL STAY HORIZONTAL.</p> <p>Check the functioning of the outriggers block valves, with boom not in the rest position:</p> <ul style="list-style-type: none"> ○ Extend outriggers and level the MEWP; ○ Push the “EMERGENCY” button to stall the engine; ○ Operate the lever for the lift and lowering of the outriggers. <p>OUTRIGGERS SHALL NOT MOVE.</p>	<p>If the problem can be solved following the instructions given in the paragraph “Trouble shooting”, perform the operations indicated in the paragraph.</p>	USER
	<p> If the problem is not solvable following the instructions indicated in the paragraph “Trouble shooting”, it is strictly forbidden to use the MEWP. Contact the Service.</p>	CMC

Inspections	In case of negative outcome of the checks:	Resolution by
<p>Check the functioning of the block valves of the boom extension cylinder:</p> <ul style="list-style-type: none"> ○ Extend the boom and set it vertically; ○ Push the “EMERGENCY” button to stall the engine; ○ Operate the extension and retraction lever of extension boom. <p>THE BOOM SHALL NOT GET BACK IN.</p> <p>Check the functioning of the block valves of the boom lifting cylinder:</p> <ul style="list-style-type: none"> - Load the basket with 200 kg (only weights). <p> During the test, it is strictly forbidden to load the MEWP with people in the basket.</p> <ul style="list-style-type: none"> ○ Extend the telescopic boom; ○ Push the “EMERGENCY” button to stall the engine; ○ Operate the lifting and lowering lever of the telescopic boom. <p>THE TELESCOPIC BOOM SHALL NOT MOVE.</p>	<p>If the problem can be solved following the instructions given in the paragraph “Trouble shooting”, perform the operations indicated in that paragraph.</p>	USER
	<p> If the problem is not solvable following the instructions indicated in the paragraph “Trouble shooting”, it is strictly forbidden to use the MEWP. Contact the Service.</p>	CMC



Inspections	In case of negative outcome of the checks:	Resolution by
Check the absence of splits, cracks, rust on the MEWP structure.	 It is strictly forbidden to use the MEWP. Contact the Service.	CMC
Check that the safety devices (emergency buttons, interlock system for outriggers-boom) work perfectly.	 It is strictly forbidden to use the MEWP. Contact the Service.	CMC
Check that the controls, the pilot lights, the emergency buttons work perfectly.	 It is strictly forbidden to use the MEWP. Contact the Service.	CMC
Check the wholeness of the cable chains.	 It is strictly forbidden to use the MEWP. Contact the Service.	CMC
Check that the blocking systems (pins, locknut, etc.) are in perfect condition and efficient.	 It is strictly forbidden to use the MEWP. Contact the Service.	CMC

Inspections	In case of negative outcome of the checks:	Resolution by
-------------	--	---------------

Check the wholeness of the flexible pipes, the pipe fitting and the components of the hydraulic circuit: check that there is no oil leakage in hydraulic circuit.	Replacement	USER / CMC
Check that the electrical contacts are not slacken.	Reset connections	USER / CMC
Check that there is no trace of clashes on the equipment.	 It is strictly forbidden to use the MEWP. Contact the Service.	CMC

8.2 ▶ Weekly maintenance (or every 40 hours) ◀

Operations	by
Check the absence of splits, cracks, rust on the MEWP counter frame (use torches or lamps to inspect the internal part under the floor).	USER / CMC
Check the cleanliness of the chassis engine and auxiliary engine* air filter.	USER / CMC
Check the cleanliness of the hydraulic filters.	USER / CMC

8.3 ▶ Monthly maintenance (or every 120 hours) ◀

Operations	by
Greasing of pins and movable parts.	USER / CMC
Washing of the equipment.	USER / CMC
Check the tightening of the bolts of the bearing, the geared power and the frame.	USER / CMC

8.4 ▶ Quarterly maintenance (or every 300 hours) ◀

Operations	by
------------	----



Check the tightening of the bolts of the bearing, the geared power and the frame.	USER / CMC
--	------------

8.5 ▶ Maintenance after the first 400 hours ◀

Operations	by
Replacement of the hydraulic filters.	USER / CMC
Registration of the movement of the arms.	CMC

8.6 ▶ Six-monthly maintenance (or every 750 hours) ◀

Operations	by
Replacement of the hydraulic filters (25 micron).	USER / CMC
Complete check of the whole machine and note the results in the appropriate manual section.	USER / CMC

8.7 ▶ Annual Maintenance (or every 1500 hours) ◀

Operations	by
Replacement of hydraulic oil.	CMC

As regards the replacement of hydraulic oil, it is advisable to follow the indications below:

1. Place the machine in the transport configuration and bring the oil to operating temperature by performing some manoeuvres before proceeding with the operations described above.
2. Suck the oil from the tank;
3. Remove the hydraulic filter;
4. Replace the filter;
5. Fill the tank by pouring the oil through a filter with a degree of filtration equal to 25 microns.

8.8 ▶ Biennial maintenance ◀

Operations	by
Complete inspection of the whole machine and note the results in the appropriate manual section.	CMC

8.9 ▶ Five-yearly maintenance ◀

Operations	by
Complete inspection of the whole machine and note the results in the appropriate manual section.	CMC

8.10 ▶ Safety rules during maintenance ◀



THE NON-OBSERVANCE OF ONE OF THE FOLLOWING SAFETY RULES CAN SERIOUSLY HARM PEOPLE OR CAUSE SEVERE DAMAGES TO THINGS OR PARTS OF THE MACHINE.

➔ To ensure the safety of the machine **the use of original spare parts installed by C.M.C. or by authorized repair shops is compulsory:** in fact, some components can be calibrated only c/or C.M.C. or in authorized workshops.



It is forbidden to perform maintenance operations when the MEWP moves: make sure that the parts to maintain are motionless and do these operations with the chassis power stalled, taking the keys away from the panel;

➔ Perform the maintenance operations in a sufficiently large space and suited to the sizes of the truck: mark the area assigned for the maintenance operations by suited enclosure or by a red/white band ribbon and do not allow entrance to unauthorized staff.

➔ Do not modify or remove safety devices.

➔ Do not modify calibrated pieces.



→ During the washing operation, do not lead the water jet directly on the electrical panels of the MEWP and do not use cleansing, aggressive chemicals dangerous for the components of the MEWP (rubber parts, painted parts, etc.).



It is forbidden to perform any intervention on parts of the MEWP, such as welding, piercing, and so on, without prior written authorization by C.M.C.

- Wear appropriate protective clothes (gloves, goggles, etc.).
- During maintenance operations, be careful not to damage the hydraulic circuit and avoid impurities in the circuit.
- Before any maintenance operation that involves the disassembly of hydraulic circuit parts, make sure that the system is not under pressure. In order to avoid violent emissions of oil, move all the levers of the control distributors, with the MEWP engine stalled and no component in movement.

8.11 ► Maintenance of endothermic engine ◀

The standard supplied engine has the following technical characteristics:

- *HONDA iGX390 petrol engine*, single cylinder OHV with horizontal shaft, 4 strokes, cylinder inclined at 25°, forced air cooling, cast iron cylinders.

Data	Value	Unit of measure
Bore x Stroke	Ø 88 x 64	mm
Cylinder capacity	389	cm ³
Net power at 3600 rpm	8.7 (11.7)	kW (HP)
Maximum torque at 2500 rpm	26.5	N/m
Dry weight	69.89	lbs
Dimensions (L x W x H)	1332 x 1509 x 1470	ft
Fuel consumption at 3600 rpm	3.5	l/h
Fuel tank capacity	6.1	l

Other engines, provided as optional*, have the following technical characteristics:

- *YANMAR L 100*, diesel engine, air-cooled, vertical cylinders, 4 strokes.

Data	Value	Unit of measure
Bore x Stroke	Ø 86 x 75	mm
Displacement	0.435	l
Continuous rated power (3000 - 3600 rpm)	5.7 - 6.2	kW
Maximum rated power (3000 - 3600 rpm)	6.3 - 6.8	kW
Dry weight	53.5	kg
Dimensions (L x W x H)	412 x 472 x 494	mm
Fuel tank capacity	5.4	l

- *Kubota Z602-E4B*, 4-cycle diesel engine, water cooled, naturally aspirated, indirect injection, 2 vertical cylinders.

Data	Value	Unit of measure
Bore x Stroke	Ø 72 x 73.6	mm
Displacement	0.599	liter
Rated Output (at 3200 rpm)	10.8 (14.5)	kW (HP)
Maximum Torque (at 2600 rpm)	37.8	Nm
Dimensions (L x W x H)	351 x 401 x 544	mm
Dry weight	57	kg
Fuel tank capacity	5.4	l



8.12 ▶ Maintenance of 48 V electric engine (*optional) ◀

The 48 V electric engine with battery pack, provided as optional* in full lithium version, has the following technical characteristics:

Battery specifics		
Battery Composition	LiFePo4	
Typical Capacity	160	[Ah]
Cells Configuration	15S1P	
Rated Voltage	48	[V]
Maximum Voltage Fully Charge	54.8	[V]
Minimum Operative Voltage	42	[V]
Rated Discharge Current	30	[A]
Maximum Discharge Current	100 (electronically limited)	[A]
Rated Charge Current	30 A (0.3 C)	
DoD	80	[%]
Battery Life Cycle	>2000 Cycle@80%DoD or >3000 Cycle@70%DoD	
Operative temperature (during charge)	-20/+60*	[°C]
Operative temperature (during discharge)	-20/+60	[°C]
Battery Weight	70 approximately	[kg]
Maximum Output Power	4.8	[kW]
Rated Energy	4.32	[kWh]

*When charge is operated at less than 0°C the charge current is electronically limited at 10 A.

Battery charger specifics		
Voltage Input	100 - 240	Vac
Frequency Input	50 - 60	Hz
Maximum Output Voltage	>=60	V
Maximum Current	22	A
PWM Frequency	1	kHz
International Protection	IP20	
Weight	2,2	Kg
Dimension (L*W*H)	180x310x100	mm

8.13 ▶ Consumables ◀

Hydraulic oil:

Gazpromneft Hydraulic	HDZ ISO	32	46
Density, 15 °C, kg/l	ASTM D1298	0,867	0,872
Kinematic Viscosity, 40 °C, mm2/s	ASTM D445	32	46
Kinematic Viscosity, 100 °C, mm2/s	ASTM D445	6,32	8,03
Viscosity Index	ASTM D2270	151	154
Pour Point, °C	ASTM D97	-42	-42
Flash Point COC, °C	ASTM D92	204	216
Air release, 50 °C, min	ISO DIS 9120	5	6
Copper corrosion, 3 hrs, 100°C	ASTM D130	1a	1a
FZG, Damaged Load, A/8, 3/90	DIN 51354	12	12

(the hydraulic tank capacity is 25 liters)

Grease:

- for arm extension and outriggers:
Interflon Grease LS1/2
Composition: mixture of mineral oils, calcium-lithium complex thickener, additives and Teflon®.
(working field: from -20°C to +120°C)
- for lubricators and bearing:
WHITE STAR NLGI 0 E 2
Composition: mixture of mineral oils and additives.
(working field: from -30°C to +110°C)
- for chains:
Interflon LUBE EP+
Composition: mixture of mineral and vegetable oils, additives and Teflon®.
Density, 20°C: 0,89 g/cm³
Kinematic viscosity, 20°C (ASTM D2983): 380 mPa.



Before oil replacement, place an oil drip tray in order to avoid the leakage of oil in the environment.

Do not disperse the exhausted oil or other consumables in the environment; put them in the appropriate containers and give them to the authorized collection centers.



8.14 ► Indications for the demolition of the MEWP ◀



In case of demolition, the machine must be dismantled completely according to the laws in force.

 The different types of materials should be distributed to the respective authorized collection centres.

The following materials must be subjected to differentiated disposal and then positioned in suitable containers:

- Ferrous materials: carpentries and mechanical components.
- Plastic materials: gaskets, belts, protections.
- Electrical materials: windings, commands, valves and similar.
- Oils and lubricants: hydraulic oil, reducers lubricants, lubricating greases.

8.15 ► Service ◀



For repairs and maintenance of your platform, refer exclusively to:

Service
C.M.C. s.r.l.
Via Bitritto, 119
70124 BARI – ITALY
Tel. +39 080 5326606
+39 080 5326557
Fax: +39 080 5368541
E-mail: info@cmclift.com

 **IMPORTANT:**

FOR ANY COMMUNICATION, PLEASE SPECIFY MODEL AND SERIAL NUMBER OF THE MEWP.



Any operation requiring interventions on the components of the machine shall be carried out only by authorized and trained staff.



Many components of the MEWP have been calibrated: a correct calibration of these parts (which is possible only in CMC or in authorized repair shops) is necessary to ensure the safety of the machine.

8.15.1 ► Remote Connection System (*optional)

The remote connection system is composed of an electronic box (Picture 88) mounted on the chassis box.



Picture 88: remote connection system.

Following the remote connection procedure:

1. Ensure that the M12 socket on the remote connection box is correctly connected to the M12 plug of the electric box mounted on the chassis;
2. Share your internet wireless network with the remote connection device in free mode (without password);
3. Lift the connection remote switch **L** on the switching on/off box (Picture 89):



Picture 89: chassis box.

- the led on the remote connection box makes two red flashes,
 - after 30 seconds, the led becomes fixed and green, to show that the operating system is working,
 - it automatically hooks up to your free network;
4. Install on your PC the TeamViewer software (11th version) to connect to the machine system, through ID and Password supplied by the manufacturer;
 5. Call C.M.C. Service for technical assistance.



9 Troubleshooting

Issue: THE CONSENT LIGHT FOR STABILIZATION DOES NOT TURN ON.

- Causes:
1. The aerial part of the MEWP is not in transport position.
 2. Failure fuse 30A battery side.
 3. Defective board.
 4. Wire removed from the battery.

- Remedies:
1. Place the aerial part of the MEWP in transport position.
 2. Check if any cable is disconnected from the battery.
 3. Replace fuse.
 4. Replace the limit switches.

If the problem persists, contact the Service.

Issue: THE STABILIZERS DO NOT WORK.

- Causes:
1. The hydraulic pump unit is faulty.
 2. Stabilizers electrovalve do not work.

- Remedies:
1. Replace the hydraulic pump.
 2. Replace the stabilizers limit switches.

If the problem persists, contact the Service.

Issue: WITH THE MEWP STABILIZED, THE CONSENT LIGHT FOR AERIAL PART USE DOES NOT TURN ON.

- Cause:
1. The green light does not work.
 2. Micro-switch system does not work.
 3. Stabilization is incomplete.

- Remedies:
1. Replace led.
 2. Replace micro-switch.
 3. Further extract outriggers up to soil contact.

If the problem persists, contact the Service.

Issue: THE AERIAL PART OF THE MEWP DOES NOT WORK.

- Causes:
1. The hydraulic pump unit is faulty.
 2. Not having switched the deadman lever on control station.
 3. The exchange electrovalve is not energized.
 4. Emergency button activated.

- Remedies:
1. Replace the hydraulic pump.
 2. Turn on and connect the control station.
 3. Replace the exchange valve.
 4. Turn the emergency button and reset the MEWP.

If the problem persists, contact the Service.

Issue: THE BASKET LEVELLING DOES NOT WORK.

- Causes:
1. Oil leakage.
 2. Cylinder seals worn.

- Remedies:
1. Tighten the hydraulic connections.
 2. Replace the seals.

If the problem persists, contact the Service.

Issue: LOW MANOEUVRES SPEED.

- Causes:
1. Pump failure.
 2. Hydraulic oil level too low.
 3. Oil filter clogged.

- Remedies:
1. Replace the hydraulic pump.
 2. Refill hydraulic oil.
 3. Replace the filter.

If the problem persists, contact the Service.



Issue: IMPOSSIBLE TO START THE ENDOTHERMIC ENGINE.

- Causes:
1. Emergency activated.
 2. Battery discharged.
 3. Out of fuel.
 4. Hydraulic oil level too low.

- Remedies:
1. Disable the emergency button.
 2. Replace the battery.
 3. Refuel.
 4. Refill hydraulic oil.

If the problem persists, contact the Service.



Contact our Service for any technical problem which is not identified nor solved by the aforesaid procedure.



10 ►► Sealings list ◀◀

For your information, hereby there is a list of the anti-tampering sealings present on the MEWP:

- proportional valves;
- valves in filters distributor;
- MEWP/stabilizers exchange solenoid valve;
- outriggers monitored electrovalve;
- yellow cap of lever for emergency bypass;
- red cap of lever for activation of emergency electropump.





The tampering or replacement of components by non-authorized staff is strictly forbidden.

→ It is mandatory to restore the sealings after use of these items.



11 ▶▶ Overload tests ◀◀

 During the commissioning of the machine, in the final test, we carried out the following overload tests. During the same, we tested S23 stability and structural resistance.

 Overload tests shall be carried out only on the first test of the machine: these tests are unique. In no other occasion shall you carry out tests with the same loads used in the overload tests.

Overload test						
Test Nr.	Load in the basket (kg)	Booms position			Movement	Out-come
		Radius (m)	Pantograph	Boom		
1	200 (PN) + 100 (CP)	11,40	completely lifted	horizontal	left side	OK
2	200 (PN) + 100 (CP)	11,40	Completely lifted	horizontal	right side	OK

NOTES.

PN: nominal payload.

CP: test load.



12 ▶▶ Operating tests ◀◀



During the commissioning of the machine, we carried out the following final operation tests. We have tested the correct operation of the S23 and of its safety systems.

Test description	Outcome
• Block of the manoeuvre in case of release of the operation lever selected.	OK
• Basket levelling allowed only when the MEWP aerial part is set in the rest position (pantograph on its support and telescopic boom on its support).	OK
• Manual pump for operations in case of emergency.	OK
• Outriggers-boom operation interlock.	OK
• Aerial part operations block when the MEWP is not stabilized	OK
• Block of the return/extension of outriggers when the MEWP aerial part is not set in the rest position.	OK
• Warning light for machine stabilized.	OK
• Warning light for electrical supply of the MEWP.	OK
• Warning light for aerial part use.	OK
• Emergency buttons in control stations.	OK
• Block valves on the cylinders.	OK
• Pressure relief valve for the protection of the entire hydraulic circuit.	OK
• Pressure relief valves for the protection of the individual parts of the system.	OK
• Fuse for the protection of the electrical system.	OK
• Anti-crash system.	OK

• Load limiter device (*optional).	OK
• Emergency electropump (*optional).	OK



13 ▶▶ Control register ◀◀

This register is used to record the following events that concern the life of the machine:

- Delivery of the MEWP to the first owner (par. 13.1)
- Further transfers of ownership (par. 13.2)
- Replacement of mechanisms (par. 13.3)
- Replacement of structural elements (par. 13.4)
- Replacement of hydraulic components (par. 13.5)
- Replacement of electrical components (par. 13.6)
- Replacement of safety devices (par. 13.7)
- Failure of a certain entity and their repairs (par. 13.8)
- Periodic inspections and maintenance log (par. 13.9)
- Notes (par. 13.10)

13.1 ▶ Delivery of the MEWP to the first owner ◀



The mobile elevating work platform
brand **C.M.C.**
model **S23**
serial number
manufacture year **2020**

has been delivered by C.M.C. s.r.l.
to the firm

according to the contractual conditions
established with the technical, dimensional and
functional features indicated in the
use and maintenance manual.

Date _____

C.M.C. s.r.l.



13.2 ► Further transfers of ownership ◀

In this day.....the property of the MEWP in question is transferred to the company/society.....

This is to certify that, at the date mentioned above, the technical, dimensional and functional characteristics of the MEWP concerned are conform to those provided in origin and that any variation has been listed on this log.

The Seller

The Buyer

In this day.....the property of the MEWP in question is transferred to the company/society.....

This is to certify that, at the date mentioned above, the technical, dimensional and functional characteristics of the MEWP concerned are conform to those provided in origin and that any variation has been listed on this log.

The Seller

The Buyer

In this day.....the property of the MEWP in question is transferred to the company/society.....

This is to certify that, at the date mentioned above, the technical, dimensional and functional characteristics of the MEWP concerned are conform to those provided in origin and that any variation has been listed on this log.

The Seller

The Buyer

In this day.....the property of the MEWP in question is transferred to the company/society.....

This is to certify that, at the date mentioned above, the technical, dimensional and functional characteristics of the MEWP concerned are conform to those provided in origin and that any variation has been listed on this log.

The Seller

The Buyer



13.3 ▶ Replacement of mechanisms ◀

Description of the element.....
 Manufacturer.....
 Supplied by.....
 Cause of the replacement.....

 Place..... Date.....
 Stamp and signature person in charge The user

.....
 Description of the element.....
 Manufacturer.....
 Supplied by.....
 Cause of the replacement.....

 Place..... Date.....
 Stamp and signature person in charge The user

Description of the element.....
 Manufacturer.....
 Supplied by.....
 Cause of the replacement.....

 Place..... Date.....
 Stamp and signature person in charge The user

.....
 Description of the element.....
 Manufacturer.....
 Supplied by.....
 Cause of the replacement.....

 Place..... Date.....
 Stamp and signature person in charge The user



13.4 ▶ Replacement of structural elements ◀

Description of the element.....
 Manufacturer.....
 Supplied by.....
 Cause of the replacement.....

 Place..... Date.....
 Stamp and signature person in charge The user

Description of the element.....
 Manufacturer.....
 Supplied by.....
 Cause of the replacement.....

 Place..... Date.....
 Stamp and signature person in charge The user

Description of the element.....
 Manufacturer.....
 Supplied by.....
 Cause of the replacement.....

 Place..... Date.....
 Stamp and signature person in charge The user

Description of the element.....
 Manufacturer.....
 Supplied by.....
 Cause of the replacement.....

 Place..... Date.....
 Stamp and signature person in charge The user



13.5 ▶ Replacement of hydraulic components ◀

Description of the element.....
 Manufacturer.....
 Supplied by.....
 Cause of the replacement.....

 Place..... Date.....
 Stamp and signature person in charge The user

Description of the element.....
 Manufacturer.....
 Supplied by.....
 Cause of the replacement.....

 Place..... Date.....
 Stamp and signature person in charge The user

Description of the element.....
 Manufacturer.....
 Supplied by.....
 Cause of the replacement.....

 Place..... Date.....
 Stamp and signature person in charge The user

Description of the element.....
 Manufacturer.....
 Supplied by.....
 Cause of the replacement.....

 Place..... Date.....
 Stamp and signature person in charge The user



13.6 ▶ Replacement of electrical components ◀

Description of the element.....
Manufacturer.....
Supplied by.....
Cause of the replacement.....
.....
Place..... Date.....
Stamp and signature person in charge The user

Description of the element.....
Manufacturer.....
Supplied by.....
Cause of the replacement.....
.....
Place..... Date.....
Stamp and signature person in charge The user

Description of the element.....
Manufacturer.....
Supplied by.....
Cause of the replacement.....
.....
Place..... Date.....
Stamp and signature person in charge The user

Description of the element.....
Manufacturer.....
Supplied by.....
Cause of the replacement.....
.....
Place..... Date.....
Stamp and signature person in charge The user



13.7 ▶ Replacement of safety devices ◀

Description of the element.....
Manufacturer.....
Supplied by.....
Cause of the replacement.....
.....
Place..... Date.....
Stamp and signature person in charge The user

Description of the element.....
Manufacturer.....
Supplied by.....
Cause of the replacement.....
.....
Place..... Date.....
Stamp and signature person in charge The user

Description of the element.....
Manufacturer.....
Supplied by.....
Cause of the replacement.....
.....
Place..... Date.....
Stamp and signature person in charge The user

Description of the element.....
Manufacturer.....
Supplied by.....
Cause of the replacement.....
.....
Place..... Date.....
Stamp and signature person in charge The user



13.8 ▶ Considerable failures and relevant repairs ◀

Description of the failure.....

.....
.....

Causes.....

.....
.....

Repair activity.....

.....
.....

Place..... Date.....

Stamp and signature person in charge The user

Description of the failure.....

.....
.....

Causes.....

.....
.....

Repair activity.....

.....
.....

Place..... Date.....

Stamp and signature person in charge The user



13.9 ▶ Periodical inspections and maintenance journal ◀

➔ The user has the obligation to respect the maintenance control program described in this manual and to register the inspections in a proper journal.

DATE	DESCRIPTION OF THE OPERATION	SIGNATURE

DATE	DESCRIPTION OF THE OPERATION	SIGNATURE



DATE	DESCRIPTION OF THE OPERATION	SIGNATURE	DATE	DESCRIPTION OF THE OPERATION	SIGNATURE



13.10 ▶ Notes



.....

.....

.....

.....

.....

.....

.....

.....

.....

.....

.....

.....

.....

.....

.....

.....

.....

.....

.....

.....

.....

.....

.....

.....

.....

.....

.....

.....

.....

.....



▶▶ Index ◀◀

0	▶▶ Introduction	◀◀ 1
0.1	▶ Content of the manual	◀ 1
0.2	▶ Disclaimer	◀ 2
0.3	▶ Where and how to store the manual	◀ 2
0.4	▶ Legislative references	◀ 2
0.5	▶ Changes and integrations	◀ 3
1	▶▶ Specifications	◀◀ 4
1.1	▶ Technical data	◀ 4
1.2	▶ Identification plate	◀ 7
1.3	▶ CE certification	◀ 7
1.4	▶ TÜV certification	◀ 7
1.5	▶ Classification	◀ 7
1.6	▶ Loading cycles	◀ 8
1.7	▶ Working diagram	◀ 8
2	▶▶ Description and scope	◀◀ 10
2.1	▶ Machine definition	◀ 10
2.2	▶ Machine purpose	◀ 10
2.3	▶ Description of the main components	◀ 11
3	▶▶ Control stations	◀◀ 13
3.1	▶ Machine switching on/off station	◀ 13
3.2	▶ Platform control stations	◀ 16
3.3	▶ Emergency control stations	◀ 22
4	▶▶ Use procedures	◀◀ 25
4.1	▶ Environmental operational conditions	◀ 25
4.2	▶ Safety distances	◀ 26
4.3	▶ Transport, storage and packaging	◀ 26
4.4	▶ MEWP operation procedures	◀ 29
4.5	▶ Lithium battery pack recharge (*optional)	◀ 34
4.6	▶ Emergency manoeuvres	◀ 34
4.7	▶ Safety rules	◀ 40
4.8	▶ Safety devices	◀ 43
5	▶▶ Markings	◀◀ 44
6	▶▶ Electrical system	◀◀ 52
7	▶▶ Hydraulic system	◀◀ 53
8	▶▶ Maintenance	◀◀ 54
8.1	▶ Daily maintenance	◀ 54
8.2	▶ Weekly maintenance (or every 40 hours)	◀ 56
8.3	▶ Monthly maintenance (or every 120 hours)	◀ 56
8.4	▶ Quarterly maintenance (or every 300 hours)	◀ 57
8.5	▶ Maintenance after the first 400 hours	◀ 57
8.6	▶ Six-monthly maintenance (or every 750 hours)	◀ 57
8.7	▶ Annual Maintenance (or every 1500 hours)	◀ 57
8.8	▶ Biennial maintenance	◀ 57
8.9	▶ Five-yearly maintenance	◀ 57
8.10	▶ Safety rules during maintenance	◀ 57
8.11	▶ Maintenance of endothermic engine	◀ 58
8.12	▶ Maintenance of 48 V electric engine (*optional)	◀ 59
8.13	▶ Consumables	◀ 59
8.14	▶ Indications for the demolition of the MEWP	◀ 60
8.15	▶ Service	◀ 60
9	▶▶ Troubleshooting	◀◀ 62
10	▶▶ Sealings list	◀◀ 64
11	▶▶ Overload tests	◀◀ 65
12	▶▶ Operating tests	◀◀ 66
13	▶▶ Control register	◀◀ 67
13.1	▶ Delivery of the MEWP to the first owner	◀ 67
13.2	▶ Further transfers of ownership	◀ 68
13.3	▶ Replacement of mechanisms	◀ 69
13.4	▶ Replacement of structural elements	◀ 70
13.5	▶ Replacement of hydraulic components	◀ 71
13.6	▶ Replacement of electrical components	◀ 72
13.7	▶ Replacement of safety devices	◀ 73
13.8	▶ Considerable failures and relevant repairs	◀ 74
13.9	▶ Periodical inspections and maintenance journal	◀ 75
13.10	▶ Notes	◀ 77